



Austroads

Research Report
AP-R492-15



Bicycle Wayfinding

Prepared by

Warren Salomon

Project Manager

Tony Arnold

Abstract

This report analyses the bicycle directional signage and wayfinding systems currently in use in Australian and New Zealand jurisdictions and provides detailed recommendations for the updating of the following sign standards and guidelines:

- AS1742.9 – Manual of Uniform Traffic Control Devices - Bicycle Facilities
- Austroads Guide to Traffic Management Part 10: Traffic Control and Communications Devices
- AS1743 Road signs - Specifications

These recommendations are based on the findings of an extensive literature review of current signage practice internationally and within Australia and New Zealand.

The literature review is available as a separate report AP-R493-15 *Bicycle Wayfinding: Literature Review*.

Keywords

Bicycle bike wayfinding sign signage route map

ISBN 978-1-925294-72-9

Austroads Project No. NT1998

Austroads Publication No. AP-R492-15

Publication date September 2015

Pages 103

© Austroads 2015

This work is copyright. Apart from any use as permitted under the *Copyright Act 1968*, no part may be reproduced by any process without the prior written permission of Austroads.

Publisher

Austroads Ltd.
Level 9, 287 Elizabeth Street
Sydney NSW 2000 Australia
Phone: +61 2 8265 3300
austroads@austroads.com.au
www.austroads.com.au



About Austroads

Austroads' purpose is to:

- promote improved Australian and New Zealand transport outcomes
- provide expert technical input to national policy development on road and road transport issues
- promote improved practice and capability by road agencies
- promote consistency in road and road agency operations.

Austroads membership comprises the six state and two territory road transport and traffic authorities, the Commonwealth Department of Infrastructure and Regional Development, the Australian Local Government Association, and NZ Transport Agency. Austroads is governed by a Board consisting of the chief executive officer (or an alternative senior executive officer) of each of its eleven member organisations:

- Roads and Maritime Services New South Wales
- Roads Corporation Victoria
- Department of Transport and Main Roads Queensland
- Main Roads Western Australia
- Department of Planning, Transport and Infrastructure South Australia
- Department of State Growth Tasmania
- Department of Transport Northern Territory
- Territory and Municipal Services Directorate, Australian Capital Territory
- Commonwealth Department of Infrastructure and Regional Development
- Australian Local Government Association
- New Zealand Transport Agency.

The success of Austroads is derived from the collaboration of member organisations and others in the road industry. It aims to be the Australasian leader in providing high quality information, advice and fostering research in the road transport sector.

This report has been prepared for Austroads as part of its work to promote improved Australian and New Zealand transport outcomes by providing expert technical input on road and road transport issues.

Individual road agencies will determine their response to this report following consideration of their legislative or administrative arrangements, available funding, as well as local circumstances and priorities.

Austroads believes this publication to be correct at the time of printing and does not accept responsibility for any consequences arising from the use of information herein. Readers should rely on their own skill and judgement to apply information to particular issues.

Summary

Directional and wayfinding signs are critical elements of any transport system to help people find their way around the network and make full use of cycle infrastructure. Signs can indicate the legal status of a facility (bike lane signs, shared path signs), regulate safe use (Stop, Give Way and parking signs), warn of potential hazards (steep descent, slippery when wet, road ahead signs), and guide cyclists to their destinations (cycle route directional and wayfinding signs). An effective system of bicycling directional signs can facilitate and legitimise the many and varied trips which cyclists make daily within our cities and towns.

Directional and wayfinding sign projects have in the past been carried out on a per-route basis. Bicycle routes can be located on-road in lanes or mixed traffic streets, off-road on bicycle paths or shared paths, or on a mixture of the two. The signing of complex routes is particularly important to facilitate connections between on- and off-road cycle facilities improving overall route cohesion.

As road authorities and local councils develop their bicycle facilities into region-wide networks, signs become an essential element in facilitating trips across a whole city, town or urban region. Signs for cycling networks can also inform bicycle riders of routes which are more direct or less heavily trafficked. Cycling network signs can help raise community awareness of the many route possibilities for bicycle travel other than single routes or the general street system.

Figure 1: Tourist/recreational route signage installed on the Brassall Bikeway, Ipswich, QLD



Source: Ipswich City Council

Contents

1. Background.....	1
2. Key Sign Issues Studied in the Literature Review.....	2
2.1 Sign systems reviewed	3
2.2 Literature review – Issues for further consideration	8
2.2.1 Use of colour	8
2.2.2 Typeface and use of capitalisation	8
2.2.3 Lettering size and legibility.....	8
2.2.4 Sign types and route hierarchy	8
2.2.5 User symbols on directional signs	8
2.2.6 Depiction of distance and the use of travel times	9
2.2.7 Route numbering, branding and naming	9
2.2.8 Retro-reflectivity issues.....	10
2.2.9 Sign system planning.....	10
2.2.10 Detour signs.....	10
2.2.11 Sign mounting issues.....	10
2.2.12 Existing sign investment	10
3. Cycling Directional Signs – Current Practices.....	11
3.1 Sign guidelines	11
3.1.1 Other ANZ sign guidelines and manuals	12
3.1.2 International guidelines practice	14
3.1.3 Australian and New Zealand guidelines practice.....	16
3.1.4 Sign guidelines recommendations.....	17
3.2 Sign types	17
3.2.1 Route hierarchy and sign families.....	18
3.2.2 Sign types recommendations	19
3.3 Sign design	21
3.3.1 Sign base and lettering/symbol colours	21
3.3.2 Bicycle symbol	22
3.3.3 Typeface and lettering size	22
3.3.4 Depiction of distances.....	24
3.3.5 Sign layout conventions.....	24
3.3.6 Sign design recommendations	24
3.4 Named facilities, numbered and branded routes.....	26
3.4.1 Naming, numbering and branding recommendations.....	27
3.5 Use of map, information and facilities signs	28
3.5.1 Map, information and facilities sign recommendations.....	30
3.6 Associated pavement markings.....	30
3.6.1 Associated pavement markings recommendations	30

3.7 Applications	31
3.7.1 Applications recommendations	32
3.8 Sign system planning.....	33
3.8.1 Sign system planning recommendations	33
3.9 Sign construction and mounting systems	34
3.9.1 Sign construction and mounting systems recommendations	34
3.10 Maintenance issues	34
3.10.1 Implementation issues recommendations	34
References	35
Appendix A Recommendation for AS1742.9 – Manual of Uniform Traffic Control Devices - Bicycle Facilities	40
Appendix B Recommendation for Austroads Guide to Traffic Management Part 10.....	47
Appendix C Recommendations for AS1743 – Road signs - Specifications	81

Tables

Table 2.1: Sign issues investigated in literature review.....	2
Table 2.2: Summary of major Australian and New Zealand cycling directional sign systems	4
Table 2.3: Summary of major international cycling directional sign systems	6
Table 3.1: Sign types used for each sign family/route types	19

Figures

Figure 1: Tourist/recreational route signage installed on the Brassall Bikeway, Ipswich, QLD.....	i
Figure 1.1: Cycle directional signs need to be visible and legible to cyclists over a very wide range of operational conditions.....	1
Figure 2.1: Danish cycle directional signage (route markers used as advance direction signs) in central Copenhagen.	3
Figure 2.2: The Switzerland Mobility signage system offers users a comprehensive nation-wide network of fully-signed routes.....	9
Figure 3.1: Australian Standard AS1742.9: Bicycle Facilities shows recommended layouts for cycle directional signs.	11
Figure 3.2: The City of Sydney has recently completed a project to fully sign its nine-route regional cycle network.	12
Figure 3.3: Fingerboard layouts recommended by the BWWG show route numbering and asset owner branding as a separately mounted sign plate.	13
Figure 3.4: The four sign types defined in Norwegian road law.	14
Figure 3.5: Dimensioned variations of the standard sign designs.....	15
Figure 3.6: Layouts for cycle network directional signs for use in the USA as defined by MUTCD 2014.....	16
Figure 3.7: Dimensioned design layouts for D1-3b and D1-3c three-line advance direction signs..	16
Figure 3.8: Sign types for cycle directional signage.	18
Figure 3.9: Sign types used for Primary Route sign family.....	19
Figure 3.10: Sign types used for Local Route sign family	20
Figure 3.11: Sign types used for Tourist / Recreational Route sign family.....	20
Figure 3.12: Typical size and location of the bicycle symbol shown in white on a blue background for primary route signage.....	22
Figure 3.13: Typeface comparison for AS1742 Modified E, FHWA 2000EX, Clearview (built-in letter spacing).	23

Figure 3.14: City of Sydney regional cycle route signage showing distances to destinations to one decimal point.	25
Figure 3.15: Branded routes with the logos integrated into the design of this advance direction sign.....	26
Figure 3.16: Route branding tags fixed externally to the fingerboard.....	27
Figure 3.17: Route numbering example from Denmark.....	27
Figure 3.18: Map sign on the Moreton Bay Bikeway, Toombul, QLD.....	28
Figure 3.19: Switzerland Mobility InfoPoint.....	29
Figure 3.20: Pavement markings indicate a cycle route turn on an inner urban street	31
Figure 3.21: Pavement markings indicate a transition from an on-road cycle lane to an off-road path, Canberra, ACT.	31
Figure 3.22: Part of the new Christchurch tourist/recreational route sign family	32
Figure 3.23: Detour signage used in Denmark	32
Figure 3.24: A section of the Inner Sydney Regional Cycle Network Focal Point Map.....	33

1. Background

In 2014 Austroads commissioned Sustainable Transport Consultants Pty Ltd to undertake a project to provide guidance to practitioners on the design of bicycle wayfinding schemes. This project seeks to improve the guidance necessary to achieve a consistent approach to bicycle wayfinding schemes in Australia. This guidance would be considered in future updates to relevant Austroads Guides including the *Guide to Traffic Management*.

The project required the consultants to investigate all aspects of signposting, road marking and other wayfinding aids which could be used in a range of situations including:

- Urban cycling networks;
- Tourism routes and trails; and,
- Other relevant cycling environments.

A key aim of the project is to provide guidance to facilitate improved bicycling directional signs thus enabling bicycle riders to better navigate cycle networks. Improvement of bicycle wayfinding is considered important for practitioners as it will assist them to deliver environmentally sustainable transport objectives.

The project is documented in two separate project reports:

1. Literature review of current guidance internationally and for Australia and New Zealand (ANZ); and this,
2. Research Report which applies the key findings and recommendations of the literature review and recommends changes to the current standards and guidelines for cycling directional signs.

The literature review produced extensive evidence of a wide range of different approaches to cycling directional signs. These are reviewed in Section 2 of this report. In Section 3, these issues and other relevant findings of the literature review are evaluated against current practice with recommendations for inclusion of new and revised sign standards and guidance in *AS1742.9*, *AS1743* and Austroads *Guide to Traffic Management Part 10: Traffic Control and Communication Devices*. These recommendations are provided as Appendices A to C of this report.

Figure 1.1: Cycle directional signs need to be visible and legible to cyclists over a very wide range of operational conditions



Note: These signs also need to be clearly recognisable as a separate system from other road signage.

2. Key Sign Issues Studied in the Literature Review

The objectives of *Bicycle Wayfinding: Literature Review of Current Practice* were to study a broad range of best practice sign systems (in ANZ and other major cycling countries) and to document the key issues relating to the design, planning and implementation of these systems. Seven countries in Europe and North America and five ANZ jurisdictions with established sign systems were studied. Other sign systems which differed significantly or offered innovative and useful sign solutions were also noted in the review.

The multi-country, multi-jurisdiction literature review was structured to examine each sign system by utilising a common set of key issues. A summary of these issues is shown in Table 2.1.

Table 2.1: Sign issues investigated in literature review

Issue	Detail investigations
National/state/ city guidelines	Do the national guidelines serve all jurisdictions? Are there state or city variations?
Sign types	Fingerboards and direction indication signs at route junctions and turnings Advance direction signs before junctions Reassurance direction signs after junctions Route markers with and without arrows Sign families for different route types (e.g. regional, local, tourist)
Layout and design of signs	Sign base colour and lettering colour Typeface, recommended letter height(s) Layout conventions (treatment of distance numerals, position of arrows, alignment etc) Design of arrows for each sign type Design of bicycle logo used Permissible use of route branding and pictograms on sign base
Provision for indicating branded, numbered or named routes	High-speed routes with limited access Long distance tourist routes International tourist routes Regional and local tourist/recreational routes Named routes
Use of map signs	Do the guidelines have recommendations on use of map signs?
Associated pavement markings	Provision for pavement markings indicating: Route turn direction Route numbering Other non-regulatory information
Sign system planning methodology	What guidance is provided on planning and implementation methodologies? Guidance on selection of destination names Guidance on focal point mapping for network wayfinding
Sign mounting systems	Are there policies and practices on placement and mounting? Information on innovative hardware and mounting systems.

Issue	Detail investigations
Applications	Other ways in which cycling directional signs may be needed and applied Detour and hazard signs Special purpose routes such as bicycle super highways etc.
Maintenance	System faults reporting

2.1 Sign systems reviewed

The literature review conducted detailed investigations of cycling directional sign systems in seven overseas countries where cycling is well developed. Additional notes and information on innovative designs and practice were included for a further four countries/sign systems.

In the case of Australia and New Zealand there are currently two systems in use, one an interpretation of the Australian Standard AS1742.9 and the other a modification of the standard highway/arterial road directional signs. Both approaches are presented through a detailed investigation of the AS1742.9 sign standard and a review of sign systems currently used in four Australian jurisdictions and in New Zealand. Additional information is also provided on recent bicycle sign developments in seven ANZ jurisdictions.

The sign issues summarised in Table 2.1 were studied in detail in the literature review. Tables 2.2 and 2.3 provide a summary of the findings for major ANZ jurisdictions and international countries.

Figure 2.1: Danish cycle directional signage (route markers used as advance direction signs) in central Copenhagen

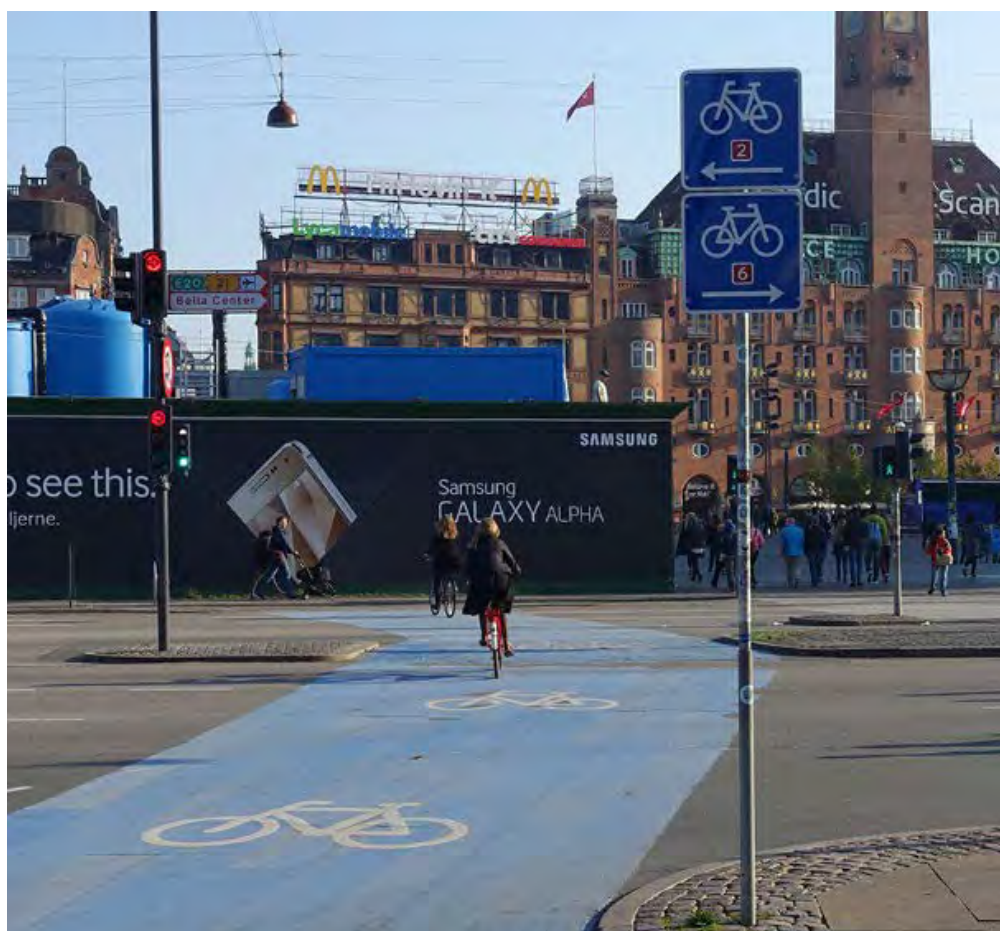

Note: These signs indicate directions for national routes 2 and 6. Source: Mike Harris

Table 2.2: Summary of major Australian and New Zealand cycling directional sign systems

Issue	Australia (national)	ACT	NSW	Victoria	Queensland	Western Australia	New Zealand
Guidelines	<i>Australian Standard AS1742 Part 9: Bicycles (AS1742.9)</i>	<i>Municipal Infrastructure Standard 5 (MIS05)</i>	<i>NSW Bicycle Guidelines (NSWBG)</i>	<i>Traffic Engineering Manual, Volume 2. Chapter 13 - Information Signs</i>	<i>TRUM Technical Note 1.36 (QTMR TRUM1.36)</i>	<i>WAMRD Road & Traffic Engineering Standards (WAMRDRTES)</i>	<i>NZ Traffic Control Devices Manual – Part 2: Direction, Service and General Guide Signs (TCDM-2)</i>
Sign design							
Sign base colour	White Retroreflective	White Retroreflective	White Retroreflective	White Retroreflective	White Retroreflective	White Retroreflective	White Retroreflective
Lettering colour	Rich Blue B11 Dark Brown X65	Dark (royal) blue AS2700 B12	Dark (royal) blue AS2700 B12	Bright Blue B23	Dark blue (PMS288) Dark brown X65	Bright Blue B23	Rich Blue B11
Typeface	AS1744 Modified E	AS1744 Modified E	AS1744 Modified E	AS1744 Modified E	AS1744 Modified E	AS1744 C Narrow	AS1744 Modified E
Letter height	80mm	60mm	65mm	40mm	60mm	40mm	Not specified
Size variations	Not specified	No sizing variations	No sizing variations	Not specified	No sizing variations	No sizing variations	No sizing variations
Numerals*	10, 9	10, 5.5, 0.1, 100m	10, 9	10, 9, 0.1	10, 5.5, 0.1, 100m	10, 9	10, 9
Route types signed	Not specified	Main Community, Local Community	Regional	Not specified	Principal, local, tourist/recreational	Principal Shared Path, Local Bicycle Route	Not specified
Sign families	Not specified	Community Route Network only	Regional route network only	Not specified	For each route type	Not specified	Not specified
Branding / Numbering							
Route branding	Not specified	Not specified	Not specified	Not specified	Yes	Yes	Yes
Route numbering	Not specified	Not specified	Not specified	Not specified	Yes	Yes	Yes
Route naming	Yes	Yes	Yes	Yes	Yes	Yes	Yes

Issue	Australia (national)	ACT	NSW	Victoria	Queensland	Western Australia	New Zealand
Tourist routes	Not specified	Yes	Not specified	Not specified	Yes	Not specified	Yes
Special routes	Not specified	Rural trails, Principal on-road training routes	Not specified	Not specified	Not specified	Not specified	Not specified
Other issues							
Map signs	Not specified	Yes	Not specified	Not specified	Yes	Not specified	Not specified
Pavement markings	Not specified	Not specified	Yes	Not specified	Not specified	Path markings	Not specified
Applications	Not specified	Not specified	Not specified	Not specified	Veloways	Not specified	Not specified
Planning guidance	Sign placement only	Sign placement only	Sign placement only	Sign placement only	Yes	Sign placement only	Sign placement only
Implementation issues	-	-	-	-	-	-	-

* Code for display of numerals: 10 = Whole kilometres above 10km, 9 = Whole kilometres under 10km, 5.5 = Format for between one and ten kilometres, 0.1 = Format for distances less than 1km, 100m = Format for distances less than 1km.

Table 2.3: Summary of major international cycling directional sign systems

Issue	Denmark	France	Germany	Netherlands	UK	USA	Switzerland
Guidelines	National guidelines binding on all levels of government	National guidelines binding on all levels of government	National guidelines as guidance to the states	National guidelines as guidance to the provinces	National guidelines as guidance to the regions	National guidelines binding on all levels of government	National guidelines binding on all levels of government
Sign design							
Sign base colour	Dark blue	White	White	White	Blue	Green	Red
Lettering colour	White	Green	Green	Red in urban areas, green in rural areas	White	White	White
Typeface	Dansk Vejtvaleskrift	F1	DIN1451 B&A	ANWB-Uu	Transport	FHWA2000-D	ASTRA Frutiger
Letter height	36-60mm	40 or 50mm	63mm	50mm	60mm	50mm	53mm
Size variations	4 sizes	2 sizes	4 sizes	None	2 sizes	None	Up to 99mm
Numerals*	10, 5.5, 0.1	10, 5.5, 0.1	10, 5.5, 0.1	10, 5.5, 0.1	10, 5½	10, 9	10, 9
Route types	National, regional and local routes	National, regional and local routes	National, regional and local routes	National, regional and local routes	National, regional and local routes	National, regional and local routes	International, national, regional, local, 'every day'
Sign families	One sign family. Route type by colour and number	Single sign family	Single sign family	Two sign families, older variations	One sign family	One sign family	Single sign family covering cycling, mountain biking and rollerblading
Branding / Numbering							
Route branding	Yes	Yes	Yes	Regional routes	Yes	Yes	Yes
Route numbering	Yes	Yes	Yes	Yes, LF	Yes	Yes	Yes
Route naming	Yes	Yes	Branded		Yes	Yes	No
Tourist routes	Yes	Yes	Yes	Yes	Yes	Yes	Yes
Special routes	CSH, Greenway	-	-	-	-	-	MTB, Rollerblading

Issue	Denmark	France	Germany	Netherlands	UK	USA	Switzerland
Other issues							
Map signs	Yes	Yes	Yes	Yes	Yes	Yes	Yes
Pavement markings	Arrows, CSH	Only regulatory	Only regulatory	Only regulatory	Only regulatory	Only regulatory	Yes for paths only
Applications	CSH, Greenway, Detour	Greenway, Detour	Detour	CSH, Detour, Numbered junctions	CSH, Detour	-	Walking trails, detour
Planning guidance	Yes	Yes	Yes	Yes	Yes	Yes	Yes
Mounting systems	Pole or frame	Pole, modular system	Pole	Pole. Special bracketing system	Pole	Pole	Pole, modular system
Implementation issues	CSH orange line trial	Consistent colour	Maintenance	Sign defect reporting	Use of retro-reflective material	-	-

* Code for display of distance numerals: 10 = Whole kilometres above 10km; 9 = Whole kilometres under 10km; 5.5 = Format for between one and ten kilometres; 0.1 = Format for distances less than 1km; 100m = Format for distances less than 1km.

2.2 Literature review – Issues for further consideration

The following sub-section summarises the significant sign issues recommended for further consideration in the literature review. More detailed consideration of these issues is provided in Section 3 as they apply to current ANZ practice.

2.2.1 Use of colour

All ANZ jurisdictions use the blue on white sign colour scheme but there is a wide variation in the colour blue used in various jurisdictions. This issue requires more precise and consistent specification of colour using a specific *AS2700* blue and its code number.

2.2.2 Typeface and use of capitalisation

Though most ANZ jurisdictions use the *AS1744* typeface (used widely on main roads directional signs) this typeface was designed for use on very large sign applications on highways and motorways and is less suitable for use on smaller signs where space constraints are often an issue. The version of this typeface currently in use in Australia is an older version of the US typeface which was upgraded in 2000 to include electronic methods of reproduction now in widespread use.

Recently a new typeface, Clearview, was developed by US agencies to improve legibility particularly in night driving conditions. This typeface has since been adopted by a number of US states. Recent sign projects in major Australian cities have made use of similar sans serif typefaces.

2.2.3 Lettering size and legibility

Letter size for highway and motorway signs is subject to formulae which take into account critical issues such as vehicle speed and the amount of information on a sign. The original *AS1742.9* recommendation of an 80mm letter height on fingerboards has been frequently unheeded in favour of smaller lettering sizes to create more compact sign designs some of which may compromise legibility, particularly from a moving bicycle.

2.2.4 Sign types and route hierarchy

Many international and local sign systems make allowance for a cycle network route hierarchy of primary/regional, local and recreational routes. This approach is useful in informing the users of the many and varied route choices offered by urban and regional cycling networks.

2.2.5 User symbols on directional signs

The standard (unelongated) bicycle symbol recommended by *AS1742.9* has been varied by a number of councils in recent sign projects. As cycle network signs are a separate and distinct system from road network sign, the recognisability of the bicycle symbol is very important particularly when signs is used within the road corridor.

A few jurisdictions have recently used the pedestrian symbol on route directional signs alongside the bicycle symbol to denote shared use. While this may not be an issue for jurisdictions where cycling is permitted on paths and the network is designed for both pedestrians and cyclists, it is not good practice when consistently signing a bicycle route to modify the sign design to introduce new graphical elements whenever the route facility changes. In jurisdictions where cycling is not permitted on paths and where bicycle routes use sections of shared paths, the required shared path regulatory sign should always be used to indicated shared use. The use of user symbols on directional signs should not in any way be confused with regulatory signs.

2.2.6 Depiction of distance and the use of travel times

In recent years there has been some limited experimentation with the use of travel times on cycle network signs. Interest in this issue has grown since the implementation of a number of internationally prominent pedestrian wayfinding and sign systems which use walking times often in place of distance (Legible London for example). Typically the use of time on pedestrian signs is over fairly short distances (though the Swiss Walking Trails system uses time for much longer routes).

Though the current UK cycle sign guidelines permit times to be used on cycle signs, there is strong opposition from the technical engineering field. Distance is a measurable, verifiable and constant no matter what the level of experience and ability of the user. Travel time on the other hand can vary widely from rider to rider particularly over longer trip distances.

2.2.7 Route numbering, branding and naming

Most of the sign systems surveyed provided for route numbering, naming and branding. There are many methods for implementing each of these. Visual examples of these are provided in Figure 2.2, Figure 3.3, Figure 3.4 and Figure 3.5. The use of graphical symbols can improve legibility and reduce the time it takes a rider to absorb the sign's message provided that the meaning and intent of the symbols used is well understood by the community. Route numbering is an abstract system now in common use on the road system with the signing of A, B, C and M roads. A similar system for cycle routes has to be widely promoted and explained to the community and repeated in all forms of public and commercial city/town street mapping.

Figure 2.2: The SwitzerlandMobility signage system offers users a comprehensive nation-wide network of fully-signed routes



Note: This route junction is fitted with an 'InfoPoint' map sign. National route number branding is included on the mounting ends of the fingerboards. Source: SwitzerlandMobility

2.2.8 Retro-reflectivity issues

Recent bicycle sign installations have generally adopted sign materials used on highway directional signs. Class 1 retro-reflective material is widely used for its high performance characteristics in the highway environment particularly at night time when lit by motor vehicle headlights. This material is not favoured by a number of European road agencies and Australian local councils for cycling directional signs as it can interfere with sign legibility due to the coarse background pattern built into the base material. In those jurisdictions Class 2 retro-reflective material is usually recommended as it provides a smooth unpatterned background, works well in diffused and low light conditions usually associated with bicycle paths and does not distract other road users from their driving tasks.

2.2.9 Sign system planning

At the time AS1742.9 was first published, there had been very little development of urban cycling networks. Since then many towns and cities have invested in cycle facilities and are building connected cycle networks. Signing a single route is a relatively simple A to B task. Signing a full network so that cyclists can access the full urban area served by the network involves a much higher level of planning, design and implementation. The QTMR publication, *A Guide to Signing Cycle Networks*, provides a methodology for signing cycle networks using the system of focal point mapping used widely by highway authorities to sign the main road network.

2.2.10 Detour signs

A suite of black on yellow signs, used to indicate short and lengthy detours during construction works, similar to that used in European countries would be a useful addition to any future upgrade of the ANZ sign guidelines.

2.2.11 Sign mounting issues

Though typically an implementation and supply issue, the availability of high quality and effective sign mounting systems can affect sign design and the way the system is presented to the public and cycle network users. The Dutch, German and Swiss sign systems make use of well-designed bracketing systems often with recessed and hidden mounting, resulting very clean-looking and attractive sign installations.

2.2.12 Existing sign investment

Given the current inadequacies and non-compliance issues raised in this review, ANZ jurisdictions and their communities would be well served by an updating of the current sign standards and guidelines. The relatively small amount of installed sign projects should not present a major barrier to such a review as it potentially would result in a more cohesive and useable system for bicycle travel overall.

3. Cycling Directional Signs – Current Practices

This section analyses current ANZ practices for cycling directional signs and compares this to the findings of the literature review for each of the key sign issues discussed in Section 2. Recommendations for an upgrade of the current sign standard and guidelines are made at the end of each sub-section.

3.1 Sign guidelines

Road traffic control and directional signs in Australia are regulated by Australian Standard AS1742 – Manual of Uniform Traffic Control Devices. Each state has the power to enact their own guidelines or modify the standard. To date, NSW, Victoria, Queensland, WA, Tasmania and the ACT have issued guidelines or advisory documents, each defining a suite of bicycling directional signs which differ from AS1742.9.

The provision of comprehensive bicycle route and network facilities has grown substantially in ANZ since the original publication of the Australian Standard AS1742.9 in 1986. A second edition in 2000 maintained the small, inadequately-specified section dealing with bicycling directional signs.

In the absence of a detailed and up to date national guidance, a number of jurisdictions have developed their own guidelines covering cycling network directional signs. These guidelines are based either on standard highway/arterial road sign designs or on an interpretation of individual sign designs used in AS1742.9. Some city governments have developed sign systems to address changes in bicycle transport such as high-quality networks (including a core of separated cycle routes) and tourist and recreational routes such as rail trails and scenic pathways.

The AS1742.9 guidance on bicycling directional signs has not been substantially upgraded since 1986. It provides basic information on sign design, colour, typeface, use of the bicycle symbol, reflectorisation and location. The Standard provides only one diagram (see Figure 3.1) which is not dimensioned or drawn to scale. Though the Standard recommends that signs and their design elements meet the Standard for general road guidance signs (AS1742.2), two different interpretations of this guidance have been developed and formalised in recent state and local government guidelines and advisory publications.

Figure 3.1: Australian Standard AS1742.9: Bicycle Facilities shows recommended layouts for cycle directional signs



Note: Detail design layouts are not provided for these signs. Clockwise from the top left: Named route direction indication sign; direction indication sign with distance; two direction fingerboards with separately mounted route name plate; and, single direction fingerboard.

3.1.1 Other ANZ sign guidelines and manuals

Additional bicycling directional guidelines and supporting resource publications and studies have been developed in a number of ANZ jurisdictions:

- NSW (as part of the 2005 *NSW Bicycle Guidelines*), City of Sydney (*Bicycle Network Directional Signage Design Guidelines*, 2010);
- Victoria (*VicRoads Traffic Engineering Manual, Volume 2, Ch. 13 - Information Signs*);
- ACT (in 2007 as part of *Design Standards for Urban Infrastructure – Part 13 Pedestrian and Cycle Facilities* currently being upgraded to *Municipal Infrastructure Standard – Part 5 Pedestrian and Cyclist Facilities Design*);
- Queensland (in 2009 as *TRUM Technical Note 1.36 - Queensland Cycle Network Signage Guidelines – updated in 2013*), *Brisbane City Council Bicycle Signage Manual*, 2014 and the Queensland Transport and Main Roads (QTMR) manual, *A Guide to Signing Cycle Networks*, 2009;
- Western Australia (*Main Roads WA Technical Guideline – Bicycling directional Signs*, 2014);
- Tasmania (*Cycle Route Directional Signage Resource Manual*. May 2013, Department of State Growth); and,
- New Zealand (*Traffic Control Devices Manual – Part 2: Direction, Service and General Guide Signs (TCDM-2)*, 2011, NZ Transport Agency and the Christchurch City Council *Bicycle Network Sign Design Manual* and *Bicycle Network Signage Plan*, 2015).

All of these guidelines and manuals have aimed to address the growing sign needs of each jurisdiction and to support and guide current practice. In Sydney, Brisbane and Christchurch these guidelines have been developed to guide the implementation of extensive sign projects across their municipal cycling networks (See Figure 3.2).

Figure 3.2: The City of Sydney has recently completed a project to fully sign its nine-route regional cycle network



Note: These fingerboards show destinations and distances at a three way junction.

Sign proposals and new sign implementation

In April 2012 a group of Melbourne Councils and government agencies under the leadership of Knox Council formed a Bicycle Wayfinding Working Group (BWWG). In August 2013 the BWWG hosted a forum in Melbourne to examine working examples developed by the group and to hear of the latest trends in signs for cycling. The forum attracted representatives from 50 organisations including state government agencies, metropolitan and rural councils, consultants, academics and bicycle user groups.

The BWWG is proposing an upgraded system of bicycling directional signs in Victoria using fingerboards, route markers and map signs, with a pedestrian logo on signs where routes are located on shared paths. BWWG proposes a route numbering system is proposed along with route branding and the use of colour to indicate route type: blue on white for major network routes, green on white for routes through parks and green spaces, and brown on white for recreational trails. Branding of signs by the asset owner/provider is proposed as a separate sign plate mounted at the top of sign stacks.

In 2014 Adelaide City Council constructed a one-way paired separated cycleway in Frome Street which runs in a north-south direction through the eastern half of the Adelaide central business district. Adelaide City Council commissioned a design company to produce a wayfinding and sign system for the new facility. The sign system features a number of features not seen before in bicycle route signs such as: vertical format sign columns mounted at rider eye height, graphical layout signs for complex intersections, pavement symbols and directional indication mounted on the tops of separating medians and facility branding attached to adjacent street poles.

In Adelaide's west, the SA Department of Planning Transport and Infrastructure and local councils are developing a greenway, between Inner Harbour and the Adelaide CBD. This route uses a mixture of shared paths and residential streets. In addition to directional signs the route also uses 'sharrow' type pavement markings as an aid to navigation.

Figure 3.3: Fingerboard layouts recommended by the BWWG show route numbering and asset owner branding as a separately mounted sign plate.



3.1.2 International guidelines practice

A useful survey of bicycle signs (regulatory and directional) in 13 countries has been undertaken by the French technical research agency, CERTU, and published in April 2014. *Signs and Signals for Cyclists and Pedestrians* (published in French and English) found that the formal rules (regulations) for direction signs are often initiated by the central government and imposed on local authorities, as in Denmark, France, Switzerland, Denmark, Norway and Sweden. In other countries, the central government establishes a regulatory framework and leaves the way open for local authorities to define their own rules, though these must be within the given framework as this guarantees that consistent designs will be used throughout the system. This situation is found in countries with a federal structure such as Austria, Germany and Spain. A third group of countries, such as Italy, Poland and the Russian Federation, do not have specific regulations for cycling directional signs – their commitment to a policy for active modes is too new and they have not yet started to create specific rules. In place of national regulations these countries have a wide range of standards and guides produced by local authorities or by user associations, complementing national regulations.

The most common practice for cycling directional signs is to define the type of signs and to resource this information with fully dimensioned working diagrams, defining important standardised elements such as colour, typeface, letter height, sign shape, symbols, depiction of distance and general sign layout conventions and rules. This is commonly done in the centralised countries by incorporating the basic designs in the legal definition of all road directional signs while the technical details are included in the relevant technical guidelines which support the standard sign designs.

A good example of this practice is in the Scandinavian countries of Denmark, Norway and Sweden. In Norway bicycle direction signs are regulated by national road law and the four permissible sign types are included in the legislation. The design details, variations and permissible uses of these signs is described in detail in *Trafikkskilt, Tekniske bestemmelser og retningslinjer for anvendelse og utforming (skiltnormal) Håndbok N300 Del 4B – Vegvisningsskilt: Detaljert Utforming* [Traffic signs, Technical Regulations and Guidelines for use and design (normal signs) Manual N300 Part 4B – Directional Signs: Detailed Design], 2014, published by the Norwegian Public Roads Directorate.

Bicycle direction signs are a distinctive dark red colour (with white lettering in the Norwegian Road Traffic Sign typeface Trafikkalfabetet) contrasting with highway directional road signs which are yellow with black lettering and motorway signs which are blue with white lettering. The system allows for numbered route branding. Green backgrounds are used for the ten national route number patches. Other routes have a dark red background – see discussion in Section 3.4.1 on these design issues.

Figure 3.4: The four sign types defined in Norwegian road law



Figure 3.5: Dimensioned variations of the standard sign designs

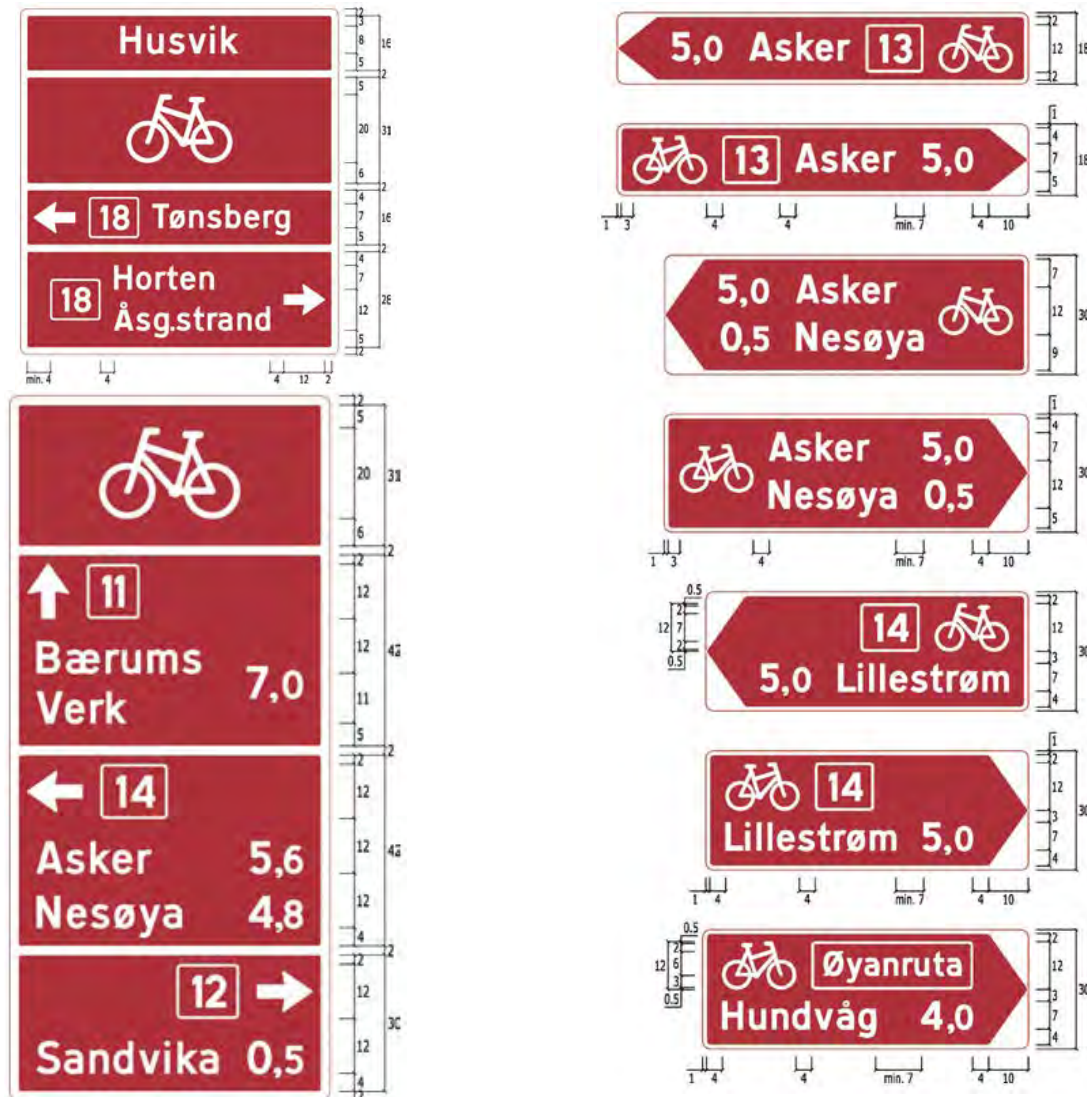

(a) variations for 753 Advance Direction signs

(b) variations for 751 Fingerboards

Source: Norwegian road signage design guidelines N300 Part 4B – Directional Signs: Detailed Design.

The US national system of road law and design/management guidelines has similarities with Australia. Road law in the USA is vested with the states and this is integrated with a national system of guidelines, the *Manual on Uniform Traffic Control Devices (MUTCD)*. The use of the *MUTCD* has been adopted into US states' road law and practice. 23 states use the *MUTCD* without modification. Others have modified or added to it to suit local conditions. The *MUTCD* applies to all roads on private property open to public access. The current edition of the *MUTCD* was released in 2009 and includes an expanded suite of guide signs for bicycle wayfinding (2012 update edition). The layout details of bicycling directional signs are specified in the *Standard Highway Signs 2004 (SHS)* and the 2012 *Supplement (SHSS)*.

Figure 3.6: Layouts for cycle network directional signs for use in the USA as defined by MUTCD 2014

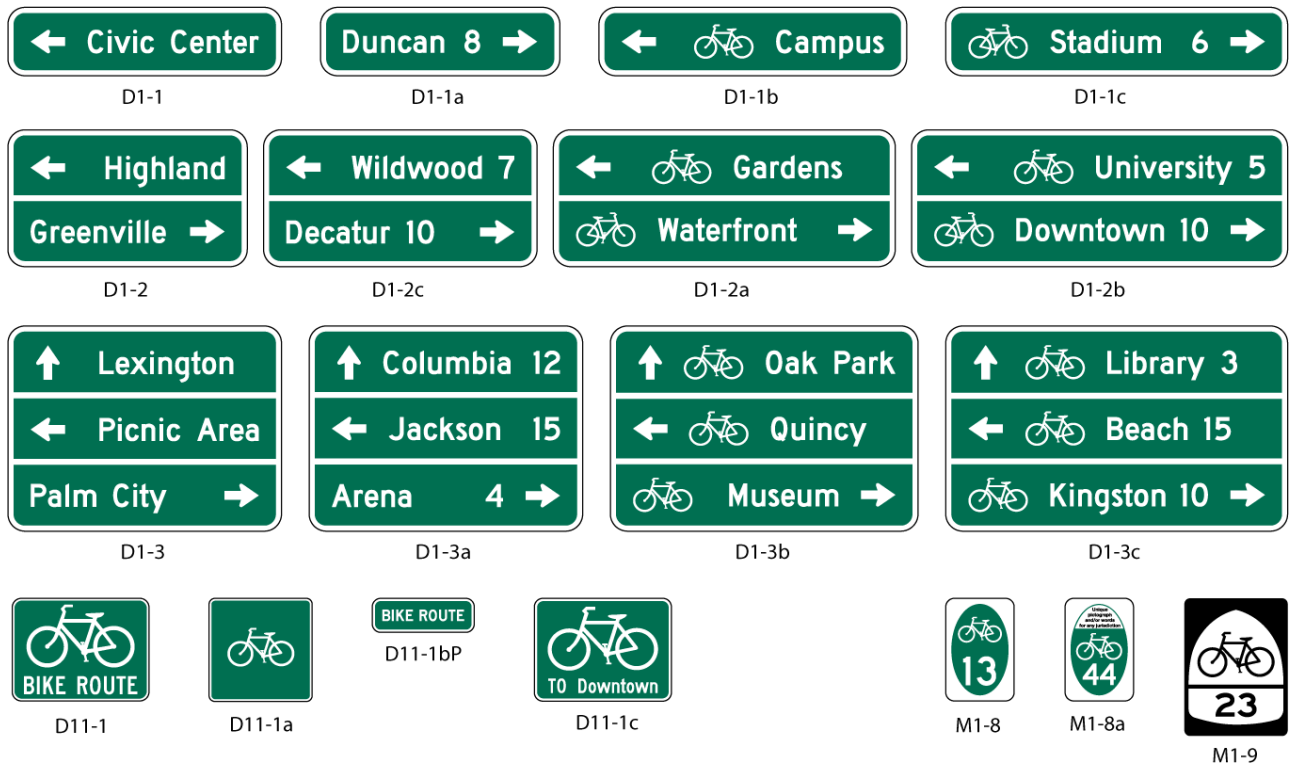
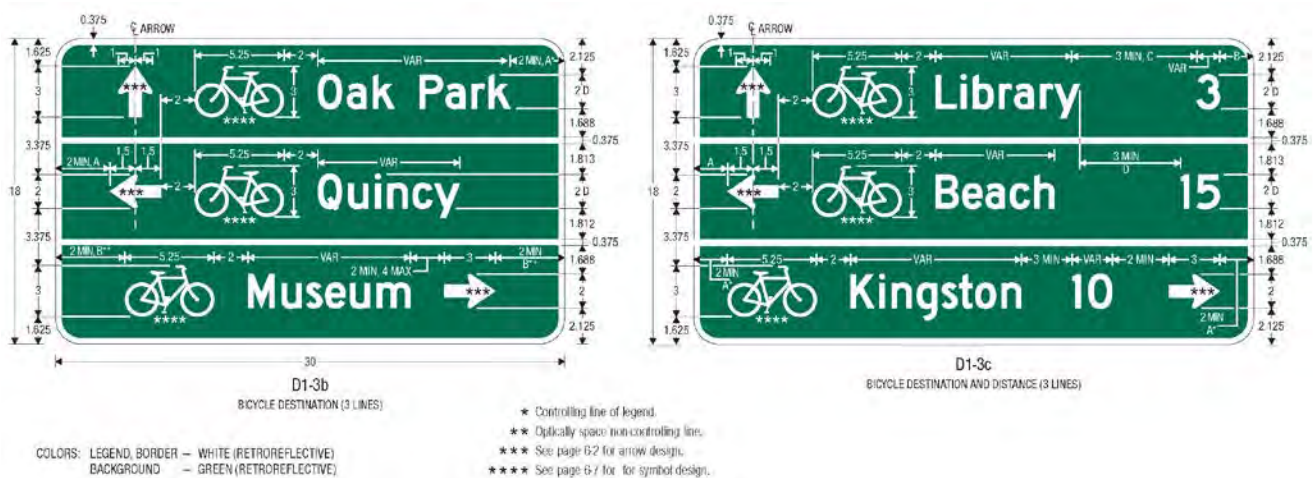

Figure 3.7: Dimensioned design layouts for D1-3b and D1-3c three-line advance direction signs



Source: 2012 Sign Design Supplement to MUTCD

3.1.3 Australian and New Zealand guidelines practice

The current model for the standardisation of regulatory road transport signs is for signs to be defined in state legislation and closely linked to the current version of the Australian Road Rules appropriate to each jurisdiction. Technical standards for the layout and colour of regulatory signs are provided in Australian Standards AS1742 – *Manual of Uniform Traffic Control Devices*, AS1743 – *Road Signs – Specifications*, AS1744 – *Standard Alphabets for Road Signs* and AS2700 *Colour Standards for General Purposes*. Bicycling directional signs are not currently included in AS1743 which provides the standard design details and dimensioning for road signs including arterial/highway directional signs.

In New Zealand the NZ Transport Agency, sets guidelines for road network signs. Directional signs are defined in the 2011 edition of the NZ *Traffic Control Devices Manual – Part 2: Direction, Service and General Guide Signs* (TCDM-2). The TCDM guideline series is intended to replace the existing signs and linemarking standard, the NZ *Manual of Traffic Signs and Markings (MOTSAM)*. MOTSAM does not include advice on cycling directional signs.

3.1.4 Sign guidelines recommendations

It is recommended that Section 5 of the Australian Standard *AS1742.9* and *Part 2: Direction, Service and General Guide Signs* of the NZ *Traffic Control Devices Manual* be updated and replaced with the recommended text and diagrams as per Appendix A of this report. The new Section 5 will define the basic sign types, colours and typefaces used and the representation of destination names and distances on signs. As it is not current practice to represent or define guidance or directional signs in legislation or regulation, their listing in an updated Section 5 of *AS1742.9* should be sufficient. It is also recommended that all other details, including sign dimensioning, design variations, sign layouts, sign planning and implementation methodologies, use of branding/symbols, route numbering, etc be included in either:

- *Austrroads Guide to Traffic Management Part 10: Traffic Control and Communication Devices* (see Appendix B of this report); or,
- *AS1743 – Road signs - Specifications* (see appendix C of this report).

3.2 Sign types

The sign names used in *AS1742.9* are imprecise and misleading and do not align with the common names used for arterial road and highway directional signs elsewhere in *AS1742* and *AS1743*.

AS1742.9 describes two sign types for use on bicycle routes: fingerboard signs for intersections (referred to as direction signs in *AS1742.9*) and advance direction/direction indication signs between junctions (referred to as route markers in *AS1742.9*). The application of the Standard across the ANZ jurisdiction in the past 25 years has resulted in two distinct interpretations:

1. Jurisdictions in NSW, ACT, Queensland and Tasmania have installed signs closely resembling a smaller scale version of the white on green standard road directional signs in blue on white.
2. Cycling directional signs used in Victoria, South Australia, Western Australia and parts of New Zealand use mostly advance direction and direction indication type signs with a layout similar to these signs depicted in *AS1742.9* Figure 5.2.

Each of these sign design variations are detailed in the following sections. The majority of international cycling directional sign systems mark route junctions and intermediate points with a range sign types similar to those used in highway/arterial road sign systems.

The basic sign types of cycling directional signs are:

- **Fingerboards** – at route junctions to indicate direction and distances;
- **Direction Indication signs** – plate/board type signs used instead of fingerboards at route junctions/turnings where fingerboard type signs would not be legible or appropriate to the location (e.g.: overhanging the roadway);
- **Advance Direction signs** – used prior to route junctions to indicate options available at the junction;
- **Reassurance Direction signs** – to assure riders that they are following the correct route and to indicate distances to destinations along the route;
- **Route markers** – simple direction arrow signs to indicate travel direction along a route;
- **Map signs** – indicating network route choices for an area;
- **Information signs** – indicating facilities and features relevant to the route; and,
- **Location signs** – simple plate type signs to mark a location such as the name of a road overpass on an off-road path.

Figure 3.8: Sign types for cycle directional signage

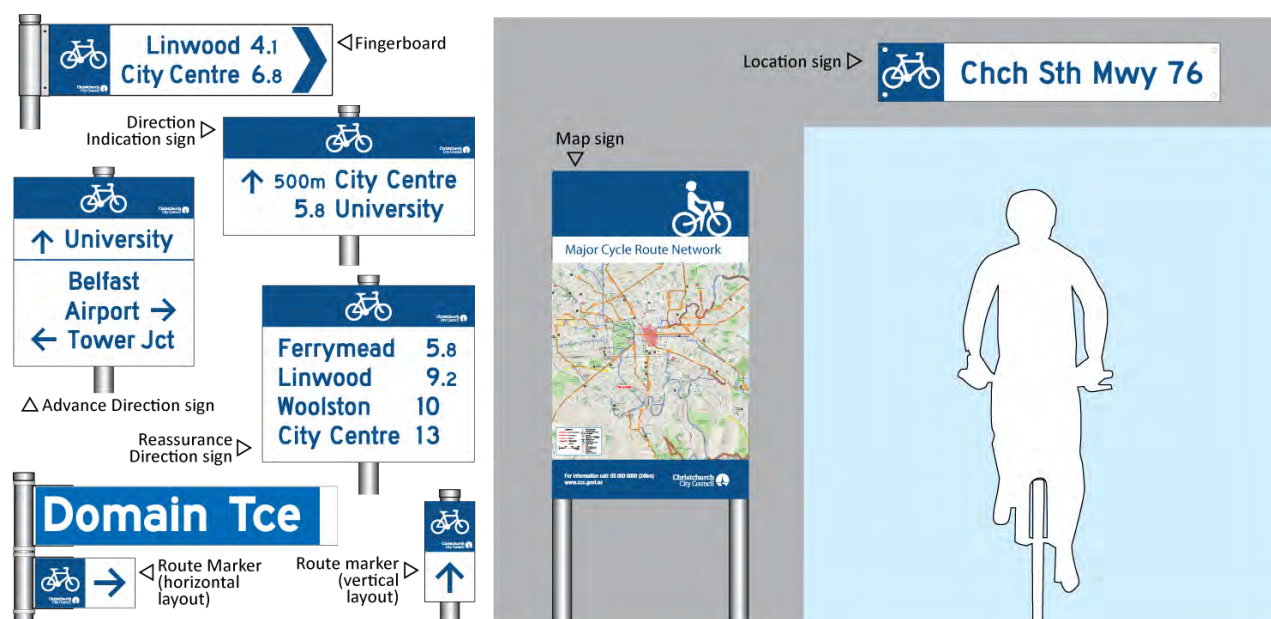

3.2.1 Route hierarchy and sign families

As noted earlier, the AS1742.9 sign standard was first published in 1986 when there were few bicycle routes and no local or regional networks. The surge in bicycle use, accompanied by the development of regional and local networks, has highlighted the need for sign systems to reflect the route hierarchy of the network.

The *Queensland Cycle Network Signage Guidelines* (2013), describe three sign families based on route type: primary/regional/principal route signs; local route signs; and, tourist/recreational route signs.

Each sign family is designed to meet the distinctive sign needs of each route type while maintaining a relatively simple and easily identifiable system.

The sign families for the three network route types are:

- **Primary/regional/principal routes** (primary routes) are the main arteries of the bicycle transport system. These routes provide safe and comfortable bicycle travel between the major centres within a city and to key centres within the surrounding region. These routes offer the most direct route alignments and minimal delays;
- **Local routes** usually branch off primary routes and provide necessary circulation within a city, town or suburb, linking to key local destinations and local activity centres; and;
- **Tourist/recreational routes** are designated routes which provide recreational and tourist cycle access within a city or town or across regions. Examples of such routes are rail trails (built along disused rail corridors), coastal trails and historical trails. These routes are usually developed in conjunction with tourism organisations and agencies.

Each route level uses a family of signs made up of different types of signs as detailed in Table 3.1. The design of signs can vary between sign families: for example, all families use fingerboards with differing design details to differentiate the type of route and its position in the network hierarchy.

Table 3.1: Sign types used for each sign family/route types

Sign type	Primary routes	Local Routes	Tourist/ recreational routes
Fingerboard	Yes	Yes	Yes
Direction Indication sign	Yes	No*	No*
Advance Direction sign	Yes	No*	No*
Reassurance Direction sign	Usually only on high-speed routes (veloways)	No*	No*
Location sign	Yes	Yes	Yes
Information sign	Yes	No	Yes
Route marker	No	Yes	Yes

* Route markers may be used for advance direction and reassurance on local or tourist/recreational routes.

3.2.2 Sign types recommendations

It is recommended that the sign types and sign families as detailed in Table 3.1 be included in the updated bicycle sign guidelines (see Appendices A to C in this report). These sign type names are similar to those used in main roads sign practice and logically describe the function of each sign type. Other recommendations for additional supporting sign details such as sign design/layouts, variations are covered in the recommendations for the following sub-sections.

Figure 3.9: Sign types used for Primary Route sign family

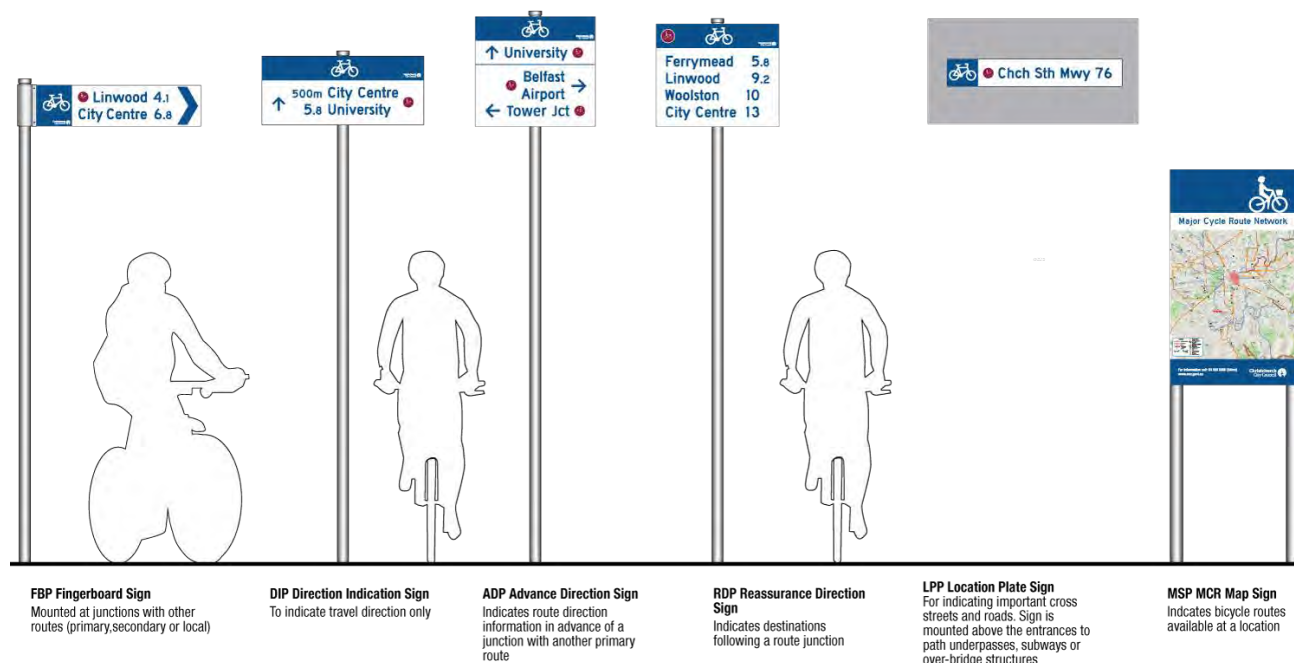

Figure 3.10: Sign types used for Local Route sign family

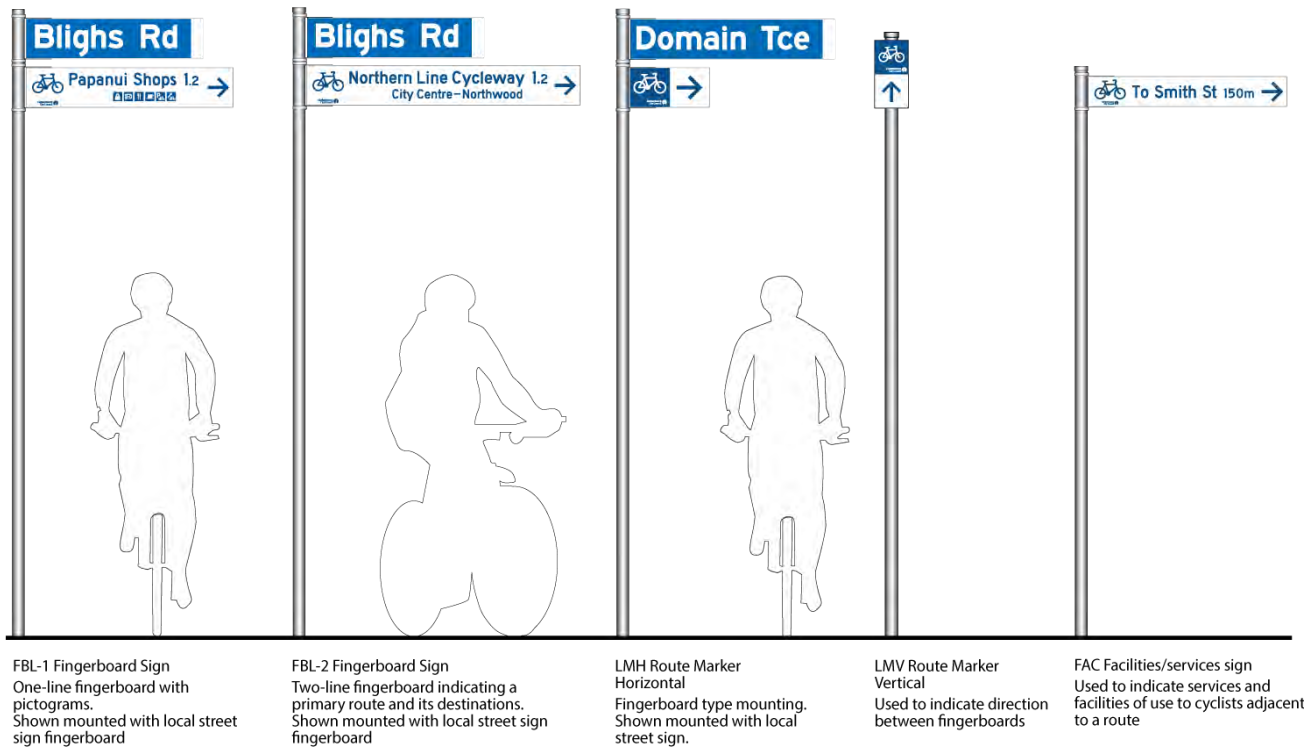
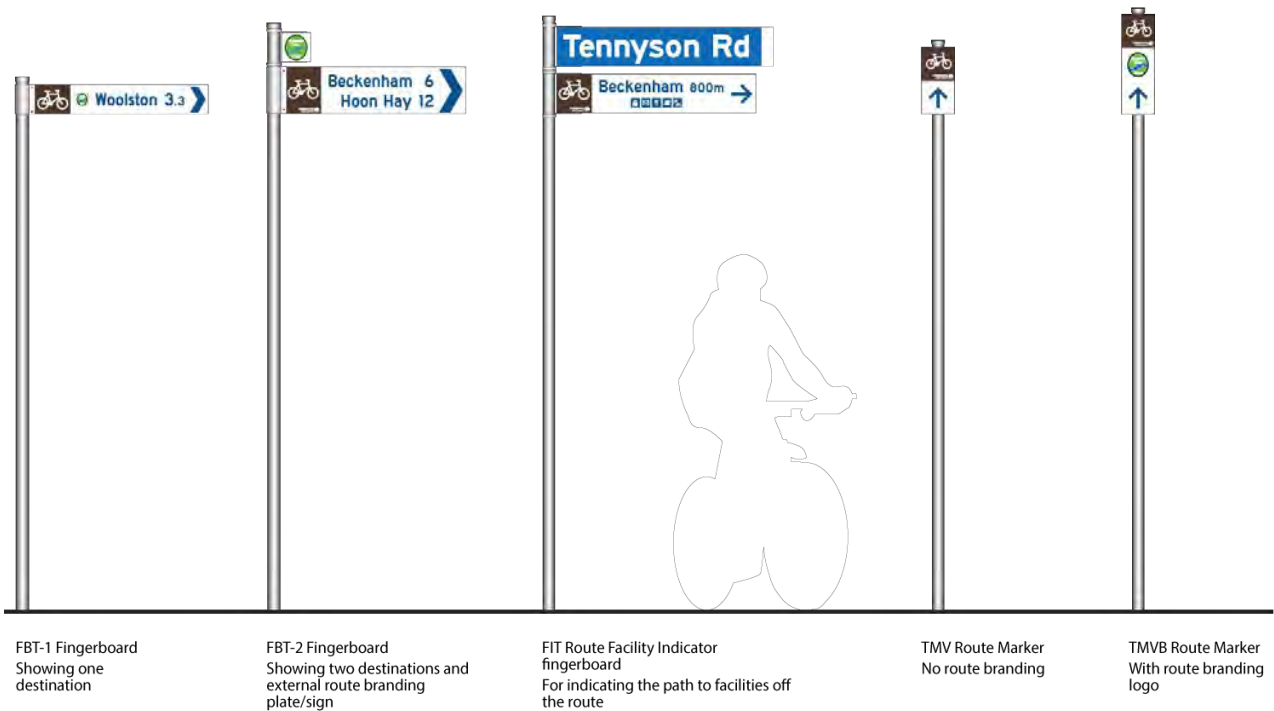

Figure 3.11: Sign types used for Tourist / Recreational Route sign family



3.3 Sign design

Most bicycle sign systems have been developed from the internationally recognised system of highway and arterial road signs in use since the early 20th Century. Highway signs, and in particular motorway signs, has been developed to cater for a different class of travel – generally at much higher speeds and in night time conditions lit by the headlights of motor vehicles. The design of cycling directional signs addresses the specific requirement of bicycle riders while also recognising that the sign system is separate from the system of arterial/highway signs and must be clearly identified as such.

The design and layout of cycling directional signs consists of five key elements discussed below in sub-sections 3.3.1 to 3.3.5 with reference to *AS1742.9*, the various ANZ applications currently in use and findings of the literature review.

3.3.1 Sign base and lettering/symbol colours

AS1742.9 specifies the base colour of bicycle direction signs as having a white background colour with blue lettering. While the white base with dark blue lettering colour scheme has universally accepted throughout all ANZ jurisdictions the colour blue has been widely interpreted. This situation is possibly a result of an inconsistency between the colour blue recommended by *AS1742.9*, which specifies *AS2700 B11 Rich Blue*, and *AS1743* which specifies *AS2700 B23 Bright Blue* for all road signs which use blue either for lettering or background colour.

AS1742.9 specifies *AS2700 B11 Rich Blue* which is a darker colour than the *AS2700 B23 Bright Blue* specified in *AS1743* which is the standard covering the design of general road signs including road directional and regulatory signs. In the interests of legibility in low-light conditions and to maintain consistency with the recommendations of *AS1743* for signs generally, *AS2700 B23 Bright Blue* is recommended for use on cycling directional signs.

A white coloured sign base is preferred to assist with sign legibility, particularly in path situations remote from street lighting or in general low-light situations.

AS1742.9 and *AS1743* both specify the use of *AS2700 X65 Dark Brown* for tourist and recreational routes. To maintain consistency with the other cycling directional sign families it is recommended that the destination lettering, distances and direction arrows on tourist/recreational fingerboards be shown in blue as for primary and local route signs with the bicycle symbol background being shown in brown.

Sign retro-reflectivity

Retro-reflectivity has different requirements for cycling directional signs compared to highway and arterial road signs. Class 1 retro-reflective material is used for traffic road signs because it is highly visible night time when lit by motor vehicle headlights. The operational characteristics of bicycle riders riding in a mixture of conditions from off-road paths to well-lit streets is different to that of motor vehicles which have high-powered lighting systems and travel at much higher operating speeds.

The legibility requirement for bicycle users is for maximum sign contrast and good overall legibility in a range of ambient lighting conditions. Class 1 material has a heavily patterned background appearance which can reduce sign legibility in low ambient light conditions, such as usually experienced on off-road paths. The heavy background pattern of Class 1 retro-reflective material can reduce sign legibility in some light conditions and is of little use to bicycles with (mostly) low-powered lighting systems operating in urban environments.

Class 2 retro-reflective material is recommended for bicycling directional signs by road authorities in Denmark as it provides a smooth unpatterned background to signs, works well in diffused and low light conditions usually associated with bicycle paths and does not distract other road users from their driving tasks (Celis 2014). US bicycling directional signs are not subject to the same retro-reflectivity requirements as other highway/arterial road direction signs.

Sustrans in the UK recommends the use of Class 2 Super Engineering Grade retro-reflective material on its signs as it provides a compliant but more durable alternative to Class 1 materials. Class 1 is more reflective, but tends to degrade more easily due to the way the material is made.

3.3.2 Bicycle symbol

The primary indicators which identify cycling directional signs and set them apart from all other road traffic directional signs are the bicycle symbol and the blue on white colour scheme. As a white on blue colour scheme is also used for some road signs (service signs, pedestrian signs and some information signs) the easily recognisable bicycle symbol is the key requirement of the cycling directional sign system in order to differentiate it from other signs.

Figure 3.12: Typical size and location of the bicycle symbol shown in white on a blue background for primary route signage



Note: Primary route fingerboard sign (left) and direction indication sign (right).

3.3.3 Typeface and lettering size

Though most applications of AS1742.9 for bicycling directional signs and its variations (in ACT, NSW and Queensland) use the AS1744 typeface Modified E, this typeface has been primarily designed for use on very large sign applications such as highways and motorways. The wide letter shape and heavy type weight produce very long and large signs often not suitable for use in urban environments.

The AS1744 Modified E typeface was reproduced for the Australian Standard using the US FHWA Typeface letter forms and spacings from the late 1940s (and updated in 1977). Since the publication of AS1744 the FHWA has revised its Modified E and other typefaces (Types B, C, D and E) to make these typefaces more suitable for the electronic methods of reproduction now in widespread use (FHWA2000EX). In recognition of the greater sign legibility by using mixed capitals and lower case, B, C, D and standard E alphabets now include lower case characters.

In recent years US road agencies have sponsored the development of a new typeface, Clearview, which was designed to improve legibility in night time conditions where the retro-reflectivity of signs reduced the legibility of the very thick letter forms used in the Modified E typeface. Clearview has since been adopted in a number of US states.

Recent sign projects have adopted similar sans serif typefaces such as Avenir Condensed (Brisbane) and Frutiger Condensed (City of Sydney). The US National Association of City and Town Officials (NACTO) design manual recommends the use of Clearview for its improved legibility.

Both the US MUTCD and SHSS (see Figure 3.6 and Figure 3.7) show bicycling directional sign layouts using the FHWA2000EX upgraded version of the Series D typeface which is narrower, has tighter letter spacing and is less bold than the older FHWA Modified E typeface upon which the current AS1744 Modified E typeface is modelled.

Typeface character spacing is an important issue for sign legibility. Experience from European countries with high cycle usage finds that cyclists and walkers can read smaller, tighter lettering than motorized road users. Tighter letter spacing can be used on bicycle direction signs (Celis 2014). US sign designs as shown in Figure 3.6 and Figure 3.7 use tighter letter spacing than *AS1744* Modified E. Tighter letter spacings can reduce the overall size of signs – an important consideration particularly for signs with lengthy destination names.

The *AS1744* typefaces have recently been revised and upgraded to match the 2000 revision of the FHWA typefaces. This enables a wider range of letter types and mixed capitals and lower case to be used for cycle route signs designed for much smaller applications.

Figure 3.13: Typeface comparison for *AS1742* Modified E, FHWA 2000EX, Clearview (built-in letter spacing)

Kingston

AS1744 Modified E 36pt

Kingston

FHWA Series EM 2000EX 40pt

Kingston

FHWA Series E 2000EX 40pt

Kingston

FHWA Series D 2000EX 40pt

Kingston

FHWA Series C 2000EX 40pt

Kingston

Clearview 4-B 40pt

Kingston

Clearview 3-B 40pt

Kingston

Clearview 2-B 40pt

Kingston

Clearview 1-B 40pt

*Note: The letter forms for the 2015 revision of *AS1744* are identical to FHWA 2000EX.*

Letter height

Most cycling sign systems have been developed from the internationally recognised system of highway and arterial road signs in use since the early 20th Century. Highway signs, and in particular motorway signs, have been developed to cater for travel at high speeds and in night time conditions.

AS1742.9 specifies a destination lettering height of not less than 80mm which is clearly intended for the fingerboard signs shown in Figure 3.1. There is a wide variation in type height and the use of capitalisation in the different ANZ sign design interpretations.

Queensland bicycling directional signs are similar in style and appearance to ACT and NSW signs. The specified typeface is *AS1744* Modified E with mixed capitals and lower case. Destination lettering is consistently 60mm high with 40mm spacing between multiple lines (lettering on NSW signs is 65mm and 60mm on ACT signs).

MainRoads WA guidelines specify *AS1744* Series C Narrow typeface (using all capitals). The specified lettering height for most signs is 40mm.

The DIN 1451 (B-version) typeface used on German highway/arterial road signs, is used on all bicycle direction signs. For situations where a very long destination name is to be shown, the A-version (condensed) is permissible. The recommended typeface size for destination lettering is 49-84mm with a 63mm character height for the most commonly used sign size.

Lettering height for other sign systems studied in the literature review are shown in Tables 2 and 3.

3.3.4 Depiction of distances

In recognition of the more locally focussed trips which are a feature of urban bicycle transport, a large number of the jurisdictions studied in the literature review displayed distances under 10 kilometres to a precision of one decimal point. Distances above 10 kilometres are rounded up to the nearest whole kilometre.

Distances less than 10km are shown to the nearest 100 metres in standard decimal form. Distances less than one kilometre are shown in metres (rounded to the nearest 100 metres e.g.: 300m). When listed on signs, the numerals and the 'm' abbreviation (no space in between) are aligned right with other destination numerals.

Distance numerals are aligned on the decimal point. Distance numerals one kilometre and above are the same point size as destination names. Numerals for distances less than one kilometre are shown in metres with numeral height 75% of the whole kilometres (45mm where the main lettering is 60mm).

Time is not recommended for use on cycling directional signs as travel times can vary widely depending on the fitness and experience of the cyclist, whereas distance is a fixed and measurable quantity.

3.3.5 Sign layout conventions

All sign designs should show the bicycle symbol, destinations and/or distances and/or a direction arrow. Fingerboards generally use a broad arrow which is usually the same height as the sign width. Other direction signs use smaller arrows. The design of arrows used on signs is dimensioned in the sign guidelines and specified as part of individual sign layouts.

Sign layout conventions determine the placement of each sign element in relation to all others. Sign layout conventions are designed to ensure rigid consistency across the sign system.

3.3.6 Sign design recommendations

Recommended sign design issues listed below are included in the recommendations contained in Appendices A to C of this report.

Sign base/lettering colour

A white coloured sign base with destination lettering, distances and arrows shown in AS2700 B23 Bright Blue is recommended for use on cycling directional signs.

Class 2 Super Engineering Grade retro-reflective material is recommended for cycling directional signs as it provides a smooth unpatterned background to signs, works well in diffused and low light conditions usually associated with bicycle paths and does not distract other road users from their driving tasks.

Bicycle Symbol

The standard unelongated bicycle symbol is recommended. The symbol is reversed out of a blue area (AS2700 X65 Dark Brown on tourist/recreational route fingerboards) located next to the mounting edge of fingerboards and to the top of all other sign types. On local fingerboards the bicycle symbol is shown in blue on a white background. The bicycle symbol always faces in the indicated direction of travel. On signs with an up arrow indicating a straight ahead direction, the bicycle symbol faces to the right.

Though there may be some variance in the symbol used by different jurisdictions, the size, alignment and placement of the bicycle symbol is always consistent throughout the sign types and families in relation to recommendations as detailed in Appendices A to C of this report.

Typeface and letter height

The new AS1744.2015 Series D typeface is recommended for the main content lettering on bicycling directional signs. Lettering height of 60mm for destination names and whole kilometres is recommended for all signs. 45mm high lettering is recommended for subsidiary information (lower lines) on local and tourist/recreational fingerboards. Destinations are always shown in a mixture of capitals and lower case.

Depiction of distances

It is recommended that distances below 10 kilometres be shown to a precision of one decimal point and all distances less than a whole kilometre be shown at 75% the height of the whole kilometres.

Figure 3.14: City of Sydney regional cycle route signage showing distances to destinations to one decimal point



Sign layout conventions

The recommendations in Appendices A to C of this report list the important sign layout rules and conventions for each sign type.

3.4 Named facilities, numbered and branded routes

Naming of facilities can add to the size and complexity of signs and its application is usually limited. Facility names on signs do not necessarily improve wayfinding as they can often place additional cognitive demands on users.

AS1742.9 makes provision for named facilities primarily through the use of additional plates mounted in association with either fingerboards or advance direction signs or integrated into the sign design.

Guidance for facility naming and route numbering and branding is included in the Queensland cycle sign guidelines. The WA guidelines provide for named facilities or numbered routes through the use of additional plates mounted in association with other signs. Route markers also include route numbering information.

The New Zealand guideline *TCDM-2* provides for named facilities, branded or numbered road routes. A number of bicycle projects have been implemented using either integrated signs or through the use of additional plates mounted in association with direction signs. NZ route markers can also include route numbering information.

Route numbering is widespread in Europe and the USA. Denmark has a numbering system for its three cycle route hierarchy as follows:

- National routes 1-15 are signed with a white number on a red background with a white border (the national colours).
- Regional routes 16-99 are signed with a white number on a blue background with a white border.
- Local routes 100-999 are signed with a white number on a blue background with a white border.

In Denmark there are two “Euro Velo” European routes. These are marked by a Euro Velo logo placed under the national route sign. There are three types of branded routes used in Copenhagen: Cycle Super Highways, Green Paths and Green Waves. Cycle Super Highways were implemented with the purpose of encouraging more longer commuting by bicycle – from the suburbs into the city. Green Paths are primarily off-road routes occupying corridors previously used as tram routes and are now linear parks. Green Waves are sections of routes where the traffic lights are coordinated to favour cyclists. At a speed of 20km/hr cyclists receive continual green lights.

Figure 3.15: Branded routes with the logos integrated into the design of this advance direction sign



Source: German national cycle directional signage system

Figure 3.16: Route branding tags fixed externally to the fingerboard



Source: German national cycle directional signage system

3.4.1 Naming, numbering and branding recommendations

Facility naming and route numbering or branding are important wayfinding tools and are an integral part of most international cycling directional sign systems. Details on the implementation of facility naming and route numbering/branding is included in the recommendations in Appendices A to C of this report.

Figure 3.17: Route numbering example from Denmark



Source: Copenhagen City Council

3.5 Use of map, information and facilities signs

Cycling directional signs usually provide guidance for one or two routes. Map signs are able to show many route choices for a wide area surrounding the map sign site. Map signs are usually located at significant network gateways to show the route options available from that location. Map signs can be used in both on-road and off-road locations with different viewing bay requirements for each location type.

AS1742.9 makes no reference to the use of map signs. In the ACT a number of map sign columns have been installed at key locations on the three-loop circuit of Lake Burley Griffin. These signs are part of a local tourism project separate from the Canberra Walking and Cycling Network sign system. In NSW a small number of map information columns have been installed in Sydney and in regional areas in association with tourist/recreational routes.

Figure 3.18: Map sign on the Moreton Bay Bikeway, Toombul, QLD



Map signs are included in the *Queensland Cycle Network Signage Guidelines*. Their use is recommended in off-road situations with careful use advised in on-street uses (viewing bays are recommended). The Brisbane City Council has installed a large number of map signs along many of its off-road bikeways. These maps use the *Brisway* street directory mapping as a base. Other maps have been installed in South-eastern Queensland as part of the Moreton Bay Bikeway – a 150km route linking communities on Moreton Bay.

In Europe, map signs are used for tourist routes as well as in urban locations. A major Dutch wayfinding innovation over the past decade is the system of numbered junctions (*knooppuntnetwerken*) implemented nation-wide across its regional cycling network. To overcome the problems of wayfinding across what is a very dense network of routes, the Dutch have developed a junction to junction system where each cycle network intersection is given a unique number and all signs associated with the system indicate numbers rather than the destination names usually used on directional signs.

To help overcome the abstract nature of route finding 'by the numbers', each numbered junction in the rural network is fitted with a large permanent map sign showing the numbered junctions and the cycle routes available from that location. Map signs are usually located at major bicycle route gateways to urban areas in the Netherlands and at key points in these urban networks. These map signs also help riders to find destinations off the cycle network in the local street system.

The SwitzerlandMobility network uses a system of 'InfoPoints' where map signs are co-mounted at key route junctions with intersection fingerboards along with a standard 'i' marker sign mounted at the top of the sign stack (see Figure 3.19). These information panels are coloured green for hikers and barrier-free routes, light blue for cyclists, ochre for mountain bikers, violet for skaters and turquoise for canoeists. These colours are used by SwitzerlandMobility to illustrate the various routes e.g. on maps, information signs and the Internet. Light-blue lines on Internet mapping indicate cycling routes. InfoPoint maps can include interpretive information such as photos and local tourist information.

Figure 3.19: SwitzerlandMobility InfoPoint



Note: At the top of the sign stack is the blue 'i' information symbol with route fingerboards below and a location map on the lower level. In locations where there may be branching mountain bike or walking routes an additional location map would be installed adjacent to the cycle network map.

Source: SwitzerlandMobility

Information signs are usually placed along a cycle route to provide information about interesting features and attractions beside or easily accessible from the cycle route. These signs can provide detailed information including informative text and graphics including photographs. These signs are mostly used on established recreational routes and are designed, implemented and maintained by the route or trail's asset manager/owner.

Facilities signs are simple fingerboards installed along bicycle routes to indicate the travel direction to a wide range of facilities which may be part of the route or accessible to it. Facilities signs can be used for the following purposes:

- Public facilities such as toilets and water for the use of cyclists and other path users;
- Path junctions on paths through parklands to indicate a connection to the local street system; and,
- Services and facilities of use to path users within easy reach of the route but not served by a signed local route – these services facilities should be easy to locate and not require additional signs.

3.5.1 Map, information and facilities sign recommendations

Map, information and facilities/services signs are an important aid to cycle route navigation and enjoyment. Guidance on the use of this type of sign is included in the recommendations in Appendices A to C of this report. Details and advice on the layout and siting of map sign viewing bays is also provided in these recommendations.

3.6 Associated pavement markings

Though *AS1742.9* makes no reference to the use of pavement markings for cycling wayfinding, a number of ANZ jurisdictions have used various bicycle symbol and arrow combinations for wayfinding.

In the ACT and NSW, government authorities and local councils have been using bicycle symbols in conjunction with reduced size turn arrows to indicate route turnings and on- to off-road transitions for at least 20 years. Across Sydney and in many regional cities in NSW, councils commonly use 800mm x 1100mm bicycle pavement symbols placed at regular intervals to indicate bicycle routes in mixed traffic conditions.

In Adelaide's west the SA Department of Planning, Transport and Infrastructure and local councils are developing a greenway between Inner Harbour and the Adelaide CBD. This route uses 'sharrow' type pavement markings as an aid to navigation. In WA, MainRoads WA permits the use of turn arrows with destination lettering on Perth's major shared path network.

Previously, only a few European countries used direction pavement markings for cyclists on roads or paths, but recent developments have seen an increase in pavement markings mainly in the development of so-called 'bicycle super highways'.

Some concerns have been expressed by traffic engineers on the use of directional pavement markings for bicycle-only use. The issues raised are their legality and the risk of confusion with other road pavement markings. In Australian road law the bicycle pavement symbol is an advisory device and it is used widely across the country on low-traffic volume mixed-traffic streets to indicate bicycle routes. The long term use of pavement markings in NSW has not resulted in road user confusion or serious incident and is considered a useful aid to navigation and the improved safety of cyclists. When indicating turns (often this is useful for on-road to off-road transitions), a standard elongated bicycle symbol is used in conjunction with turn arrows to clearly indicate that the markings are intended for cyclists.

3.6.1 Associated pavement markings recommendations

Details for the layout and application of on-road pavement markings to indicate route turnings for cyclists in low-volume mixed-traffic conditions are recommended and are included in the recommendations in Appendices A to C of this report.

Figure 3.20: Pavement markings indicate a cycle route turn on an inner urban street, Newtown, NSW



Figure 3.21: Pavement markings indicate a transition from an on-road cycle lane to an off-road path. Canberra, ACT



3.7 Applications

The literature review studied bicycle wayfinding both within and beyond the more conventional approach to route signs. Signing specialised facilities such as greenways, rail trails and cycle super highways were among the projects reviewed.

AS1742.9 does not include information on directional signs for other than conventional transport or tourist/recreational bicycle routes. There are a number of tourist/recreational projects such as rail trail development underway across Australia. There is currently little guidance for signing this type of route.

In Southeast Queensland, the Department of Transport and Main Roads is currently implementing its first 'veloway' between Brisbane and the Gold Coast. This route is designed to parallel the M1 Motorway and offer cyclists a limited-access, high-speed route. QTMR is progressively signing this route which includes a number of complex junctions where the route has to traverse feeder roads associated with the Motorway.

Figure 3.22: Part of the new Christchurch tourist/recreational route sign family

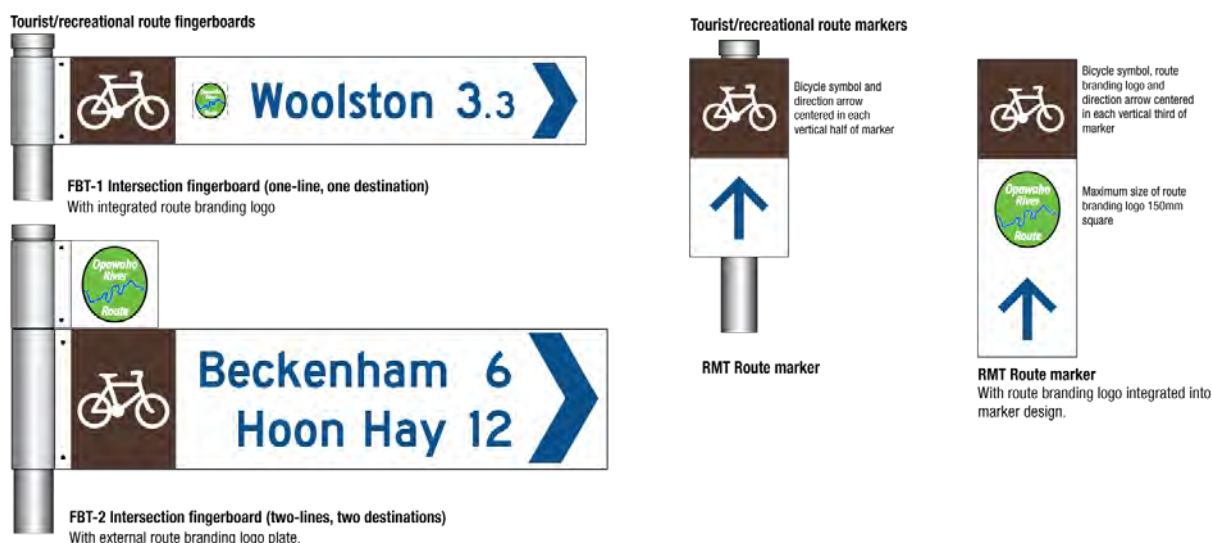

Source: Christchurch City Council Cycle Sign Design Manual.

In Europe most countries use a small suite of signs in the traditional warning colour scheme of black lettering on a yellow background to temporarily mark routes or sections of routes to warn cyclists of roadworks and to indicate long-term detours.

Figure 3.23: Detour signage used in Denmark



Note: The blue sign is the normal cycle route marker sign. Yellow signs with black lettering are recognised internationally as indicating a warning or hazardous conditions.

3.7.1 Applications recommendations

Design, layout and application details for veloway, tourist/recreational signs, and detour signs for cycle routes under construction are recommended and are included in the recommendations in Appendices A to C of this report.

3.8 Sign system planning

Signing a single route is a relatively simple process of signing destination 'A' to destination 'B' and all sub destinations in between. Signing a network is much more complicated as the users must be able to navigate their way around a wider area using more than a single route.

A transport network functions more like a mesh or a web rather than a linear route. Cyclists may need to plan their journeys and take a number of routes to get to their destinations. The fineness of the network mesh is particularly important to cyclists as trip choice is often dependent on a range of factors such as slope/terrain, traffic density, route attractiveness, preferred travel speed and the quality of the available bicycle route infrastructure.

Advice on the planning of cycling network signs is provided in a few of the sign guidelines reviewed by the literature review. Comprehensive and detailed methodology for sign planning, including focal point mapping procedures, is included in the *Queensland Cycle Network Directional Signage Guidelines* and in the QTMR publication *A Guide to Signing Cycle Networks*. This methodology has subsequently been implemented in Southeast and Far North Queensland regions.

3.8.1 Sign system planning recommendations

Details and advice for cycling network sign system planning modelled on the Queensland sign guidelines are recommended and included in Appendix B of this report.

Figure 3.24: A section of the Inner Sydney Regional Cycle Network Focal Point Map

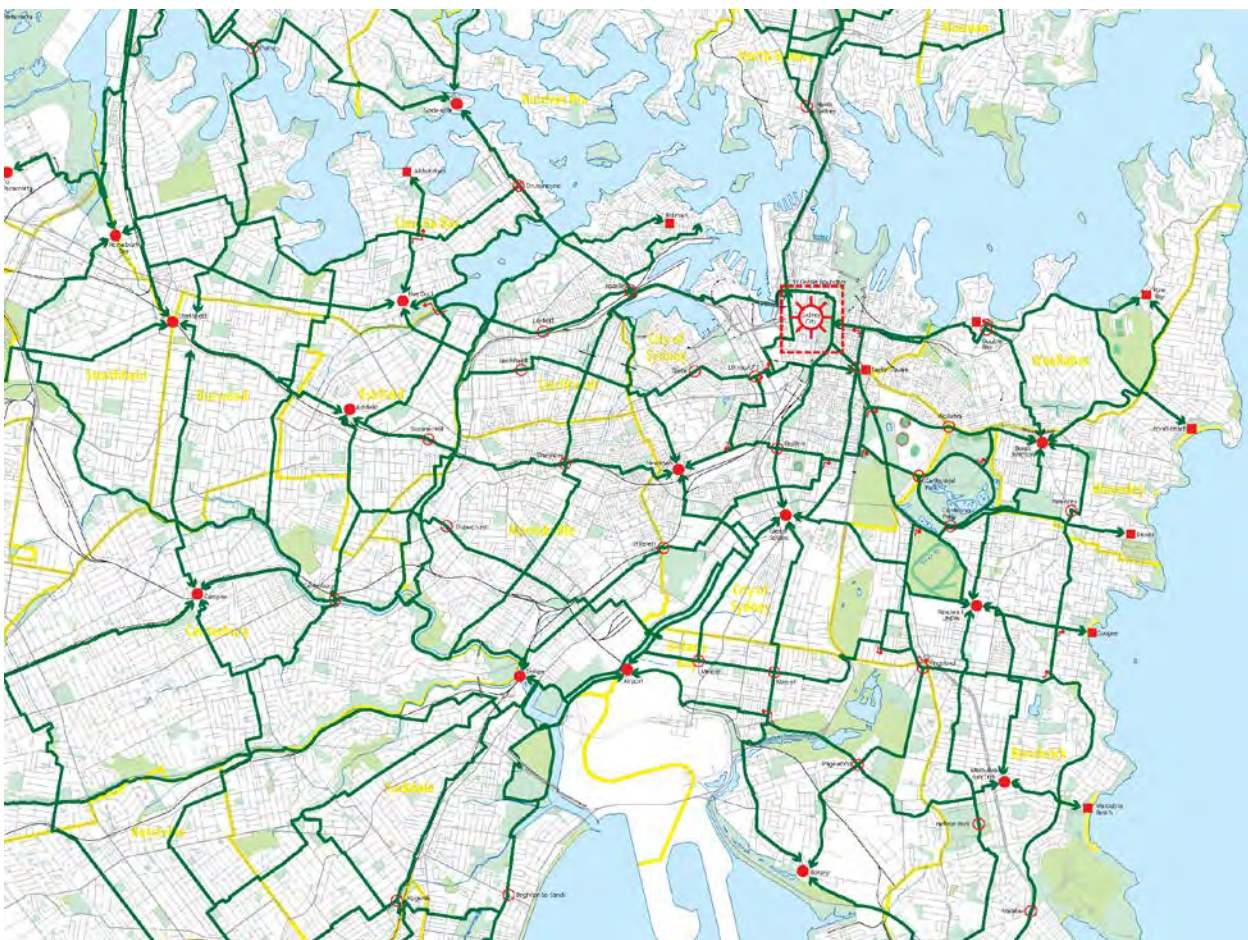

Note: This is an essential tool for planning sign planning and installation across an urban regional cycle network.

3.9 Sign construction and mounting systems

Sign mounting and construction issues are rarely given detailed coverage in sign guidelines. Advice on suitable commercially-available mounting systems is a useful addition to sign guidelines to ensure a high quality installation. This may include advice preferred hardware types for sign posts, mounting brackets and sign base materials.

The Swiss system uses standard-size end-mounting fingerboards. Smaller fingerboard-type marker signs are made from 5mm aluminium plate with standard two bolt fixing arrangement. Larger fingerboards use a similar construction to German signs consisting of a hollow section aluminium fingerboard with recessed mounting.

ANZ sign systems commonly use 6mm aluminium sheet for double sided fingerboards. All other board/plate type signs are usually fabricated from 1.6mm aluminium sheet with U-section fixing/stiffening channels fixed to the rear of the sign. Most available mounting systems are based on this type of sign fabrication.

3.9.1 Sign construction and mounting systems recommendations

Advice and recommendations for sign manufacture and fixing modelled on current ANZ best practice are included in the recommendations in Appendix C of this report.

3.10 Maintenance issues

This sub-section looks at the issues affecting the ongoing maintenance of cycling directional signs. Directional signs are like links in a chain. If a single sign is removed it is possible for users to lose their way and community confidence in the system begins to break down. Asset managers/owners are increasingly interested in accurate reporting systems which will allow them to more efficiently maintain systems such as cycle network directional signs.

With such a large cycle network to sign and maintain, the amount of upkeep on the Dutch cycling networks is considerable. Nationally, maintenance is shared between a range of authorities depending on ownership or management of the particular route. This system is Internet-based and encourages users to report faults in signs, surface and road/path condition to a central agency.

LF-routes are consistently maintained by the *Fietsplatform* organisation. If the signposting on LF-routes is damaged or missing, cyclists can report these defects to the *Meldsysteem Bewegwijzering Fietsroutenetwerken* (Cycle Reporting System for Cycle Networks) at www.nederlandfietsland.nl. This agency then notifies the correct maintenance authority (asset owner/manager) for the route location/segment reported.

3.10.1 Implementation issues recommendations

Advice on sign maintenance and sign defect reporting systems are included in the recommendations in Appendix B of this report.

References

International Jurisdictions

A useful survey of bicycle signs (regulatory and directional) in 13 countries has been undertaken by the French technical research agency, Centre d'études sur les réseaux de transport et l'urbanisme (CERTU) and published in April 2014. This research is available from the CERTU website as a research report and thirteen individual information sheets (published previously in November 2013). The original aim of the CERTU project is to survey more countries.

The CERTU report *Signs and Signals for Cyclists and Pedestrians* (in English) is downloadable from: <http://www.certu-catalogue.fr/signs-and-signals-for-cyclists-and-pedestrians.html>

The 13 information sheets (also available in English) can be downloaded from: <http://www.certu-catalogue.fr/signs-and-signals-for-active-transport-modes.html>

Denmark

A Collection of Cycling Concepts. 2012. Danish Cycling Embassy. Copenhagen, Denmark. Downloadable from: <http://www.cycling-embassy.dk/2013/08/01/cycle-concepts2012/>

Cycle Super Highway Existing and Planned Routes. 2014 City of Copenhagen Technical and Environmental Administration. Copenhagen, Denmark.

Håndbog I Cykeltrafik — En Samling af de Danske Vejregler På Cykelområdet (Bicycle Facilities Handbook – Cycling Aspects of the Danish Road Guidelines) — May 2014. Celis Consult (with support from the Danish Road Directorate). Copenhagen, Denmark. Downloadable from: <http://www.celis.dk/?p=152>

Jantzen, P. 2014, September. Personal communication with Mike Harris.

Service Katalog: Cykelsuperstier, Region Hovedstaden. 2013. Technical-and-Environmental-Administration. City of Copenhagen. Copenhagen, Denmark.

Vejregel Færdselsregulering Vejvisning Hæfte 4 Vejvisning På Cykel-, Ride- Og Vandreruter (Road Standard: Traffic Control Directions Issue 4 Directions cycling, riding and hiking trails). 2009. Danish Road Directorate. Copenhagen, Denmark.

Vejregel Færdselsregulering Vejvisning Hæfte 4 Vejvisning På Cykel-, Ride-Og Vandreruter — Tegningsbilag (Road Standard: Traffic Control Directions Issue 4 Directions cycling, riding and hiking trails – Drawing Appendix). 2008. Danish Road Directorate. Copenhagen, Denmark. Downloadable from: <http://vejregler.lovportaler.dk/ShowDoc.aspx?docId=vd-20101203132107889-full&q=vejvisning+h%C3%A6fte+4>

France

Signalisation des Aménagements et Itinéraires Cyclables. 2004. Centre d'études sur les réseaux de transport et l'urbanisme (CERTU). Lyon, France. CERTU publications can be downloaded from: <http://www.certu-catalogue.fr/>

Recommandations pour les aménagements cyclables (RAC). 2008. (English version also available). CERTU. Lyon, France. This manual has some details on signs.

Guide de signalisation de EuroVelo 6 (Guide to Signage for EuroVelo Route 6). 2007. Orléans, France. Document downloadable from: <http://www.departements-regions-cyclables.org/page/signalisation—p-22.htm>

Voies Verte Velo (VVV) national Bicycle and Green Routes web portal: <http://www.francevelotourisme.com/>

Germany

Empfehlungen für Radverkehrsanlagen 2010 (ERA) (Guidelines for Bicycle Facilities).

Forschungsgesellschaft für Strassen- und Verkehrswesen (FGSV). Cologne, Germany. Obtainable (in German only) from:

http://www.fgsv-verlag.de/catalog/product_info.php?products_id=2869

Merkblatt zur Wegweisenden Beschilderung für den Radverkehr 1998 (Information for Directional Signing for Bicycle Traffic). Forschungsgesellschaft für Strassen- und Verkehrswesen (FGSV). Cologne, Germany.

Obtainable (in German only) from: http://www.fgsv-verlag.de/catalog/product_info.php?products_id=433

Bavarian Bicycle route Network (Bayernnetz für Radler) web portal: <http://www.bayerninfo.de/rad>

D-Netz the national network of cyclo-tourist routes. Web portal at: <http://www.radnetz-deutschland.de/>

Netherlands

Richtlijn bewegwijzering 2014 (Directional Signage) Publication 322. CROW (Centre for Regulatory and Research into Road Construction and Traffic Engineering). Ede, The Netherlands. This manual is only available in Dutch.

<http://www.crow.nl/publicaties/richtlijn-bewegwijzering-2014>

Stichting Landelijk Fietsplatform (National Cycling Platform Association). The Fietsplatform website (in Dutch): <http://www.fietsplatform.nl/>

Fietsplatform's *Nederland-Fietsland* website has detailed information about the cycling network and bicycle travel in the Netherlands in French, German and English: <http://www.nederlandfietsland.nl/en>

United Kingdom

Traffic Signs Regulations & General Directions 2002 (TSRGD) UK Department for Transport (DfT) London, UK. Amendments to TSRGD were published in 2011 and a full revision of TSRGD is expected in 2015

London Cycling Design Standards. Draft for consultation June 2014. Transport for London, London, UK.

Technical Information Note 5 – Cycle Network Signing. 2012. Sustrans. Bristol, UK. Available on the Sustrans website: <http://www.sustrans.org.uk/sites/default/files/images/files/migrated-pdfs/Technical%20Note%205%20-%20Signs%2005%281%29.pdf>

USA

Manual on Uniform Traffic Control Devices – Part 9 Traffic Controls for Bicycle Facilities (2009 Edition). Federal Highway Administration. Washington, USA. Downloadable from:

http://mutcd.fhwa.dot.gov/kno_2009r1r2.htm

Standard Highway Signs 2004 Edition — 2012 Supplement (for use with MUTCD 2009). 2012. Federal Highway Administration. Washington, USA. Downloadable from: http://mutcd.fhwa.dot.gov/ser-shs_millennium.htm

Urban Bikeway Design Guide. 2013 2nd Edition. National Association of City Transport Officials (NACTO).

Only available as a hard copy. Information and ordering at: <http://nacto.org/cities-for-cycling/design-guide/>

Switzerland

Strassensignale; Signalisation Langsamverkehr, inkl Anhang Signalisation Langsamverkehr Abmessungen SN 640 829a. 2006. (Road signs: Slow Traffic Signage with Sign Dimensions Appendix). Schweizerischen Verband der Strassen- und Verkehrsfachleute VSS (Swiss Association of Road and Transportation Experts). Zürich, Switzerland. Web viewer at: <http://www.vss.ch/de/webviewer/viewdocument/4072/dHash/de3cb700fecf364bd391cbe9590135717f396e8d/>

SwitzerlandMobility Foundation. Organisational website at: <http://www.switzerlandmobility.org/switzerlandmobility.html>

SwitzerlandMobility cycling website at: <http://www.veloland.ch/en/cycling-in-switzerland.html>

EuroVelo

Signing the EuroVelo Network. 2010. European Cyclists Federation. Brussels, Belgium. The EuroVelo branding style manual is downloadable from: http://www.eurovelo.org/wp-content/uploads/2011/08/EuroVelo_Signing1.pdf

The ECF website for the EuroVelo project has a comprehensive technical publications section for stakeholders: <http://www.eurovelo.org/downloads/guidelines/>

Norway

Trafikksignalanlegg, Vegoppmerking, Trafikkskilt, Arbeidsvarsling N300 (Traffic Lights, Road Markings, Traffic Signs and Roadworks N300 – Parts 1 to 5). 2014. Statens vegvesen Vegdirektoratet (Norwegian Public Roads Directorate). Oslo, Norway. Website for design manuals: <http://www.vegvesen.no/Fag/Publikasjoner/Handboker/handboker-etter-hovedtema>

Syklist Velkommen (Cycling Norway) is an association which works with governments and private sector partners to develop the national ten route cycling network. Website: <http://www.cyclingnorway.no/>

Sweden

Vägmärkesförordningen, VMF (2007:90) (Swedish Traffic Sign Regulations 2007:90) <http://transportstyrelsen.se/sv/Vag/Vagmarken/Lokaliseringsmarken-for-gang-och-cykeltrafik/>

Cykelexpressrutter (Cycle Express Routes study for the Öresund Region of Sweden and Denmark). <http://www.trafikverket.se/PageFiles/116610/cykelexpressrutter.pdf>

Italy

Codice della Strada (Italian Highway Code) and *Regolamento di Attuazione del Codice della Strada* (Regulations and Implementation of the Highway Code). 2005 with 2013 rev. Department of infrastructure and Transport. Rome, Italy.

Bicitalia: Rete Ciclabile Nazionale Linee guida per la realizzazione. 2008. Federazione Italiana Amici della Bicicletta (FIAB). Mestre, Italy. Downloadable from (site registration required): <http://www.fiab-areatecnica.it/component/attachments/download/1.html>

Australian Jurisdictions

Australian Standard AS1742.9 and referenced Standards

Australian Standard AS1742 Manual of Uniform Traffic Control Devices – Part 9: Bicycle Facilities. 2000. Standards Australia. Sydney NSW. Available for purchase from:
<http://infostore.saiglobal.com/store/Details.aspx?productID=244960>

Australian Standard AS1743 Road Signs – Specifications. 2001. Standards Australia. Sydney NSW. Available for purchase from: <http://infostore.saiglobal.com/store/Details.aspx?ProductID=245018>

Australian Standard AS1744 Forms of letters and numerals for road signs (known as Standard alphabets for road signs). 1975. Standards Australia. Sydney NSW. Available for purchase from:
<http://infostore.saiglobal.com/store/Details.aspx?ProductID=245025>

Australian Standard AS2700 Colour Standards for General Purposes. 2011. Standards Australia. Sydney NSW. Available for purchase from: <http://infostore.saiglobal.com/store/Details.aspx?ProductID=1464464>

Australian Capital Territory

Municipal Infrastructure Standard – Part 5 Pedestrian and Cyclist Facilities Design. 2014. ACT Territory and Municipal Services Directorate. Canberra, ACT.

ACT Standard Drawings ACTSD-0000 and ACTSD-0000 – WCN Directional Signage Designs and Specifications. 2014. ACT Territory and Municipal Services Directorate. Canberra, ACT.

Planning for Cycling and Walking in the ACT. 2014. ACT Government. Canberra, ACT.

These documents can be downloaded from: <http://www.tams.act.gov.au/>

New South Wales

NSW Bicycle Guidelines. 2005. NSW Roads and Maritime Services. Sydney, NSW. Available for download at: http://www.bicycleinfo.nsw.gov.au/downloads/nswbicycleguidelines_12a_i.pdf

Bicycle Network Directional Signage Design Guidelines. 2010. City of Sydney. Sydney NSW.

Bicycle Network Directional Signage Graphic Specifications and Artwork Templates. 2013. City of Sydney. Sydney NSW

Queensland

Traffic and Road Use Manual Section 1.36, Queensland Cycle Network Directional Signage Guidelines. 2009. Department of Transport and Main Roads. Brisbane, Queensland. Part of TRUM Volume 1 – download from:
<http://tmr.qld.gov.au/business-industry/Technical-standards-publications/Traffic-and-Road-Use-Management-manual.aspx>

A Guide to Signing Cycle Networks. 2009. Department of Transport and Main Roads. Brisbane, Queensland. Download from: <http://tmr.qld.gov.au/Travel-and-transport/Cycling/Bike-user-guide/Technical-information.aspx>

Brisbane City Council Bicycle Signage Manual. 2014. Brisbane City Council. Brisbane, Queensland.

Western Australia

MRWA Technical Guideline – Bicycling directional Signs. 2014. Main Roads Western Australia. Perth, WA. Web-based guidelines accessed at: <https://www.mainroads.wa.gov.au/BuildingRoads/StandardsTechnical/RoadandTrafficEngineering/TrafficManagement/BicycleDirectionalSigns/Pages/home.aspx>

New Zealand

Traffic Control Devices Manual – Part 2: Direction, Service and General Guide Signs. 2011. NZ Transport Agency. Wellington, New Zealand. Download from: <http://www.nzta.govt.nz/resources/traffic-control-devices-manual/index.html>

Manual of Traffic Signs and Markings (multiple parts). 2010. NZ Transport Agency. Wellington, New Zealand.

Bicycle Network Sign Design Manual. 2014. Christchurch City Council. Christchurch, New Zealand.

New Zealand Cycle Trail – web portal: <http://www.nzcycletrail.com/>

Victoria, South Australia

Bicycle Wayfinding Working Group. Documents and presentations from the 2013 BWVG Forum are available for download at: http://www.knox.vic.gov.au/Page/Page.aspx?Page_Id=3712

Frome Street Cycleway. Information on signs for this project can be viewed at: <http://aspect.net.au/?p=3640>

Tasmania

Cycle Route Directional Signage Resource Manual. 2013. Department of State Growth. Hobart, Tasmania. Downloadable from: http://www.transport.tas.gov.au/passenger/cycling_and_walking/signage

Rail Trails Australia

Signage Development for Rail Trails. 2004. Rail Trails Australia. East Melbourne, Victoria. Downloadable from: http://www.railtrails.org.au/images/documents/ra_signs_ver_1.0.1.pdf

Appendix A Recommendation for AS1742.9 – Manual of Uniform Traffic Control Devices - Bicycle Facilities

A.1 General

This Section specifies the basic layouts and key elements for the design and provision of bicycle route directional signs. It is intended that, subject to adherence to these basic layouts and key elements, flexibility in the design and presentation of navigational information is permitted.

The objectives of these basic layouts are as follows:

- To maintain a degree of standardization which allows a cyclist encountering signs for the first time to immediately recognize them as navigational aids aimed specifically at cyclists.
- To ensure that bicycle navigational information cannot be misread by motor vehicle drivers in situations where this could create a hazard.
- To ensure that safety principles in the use of colour and sign reflectorisation are observed.

The following sub-sections provide guidance on the key design elements for bicycle directional signs. Technical information, design details and dimensioning for all cycle network directional sign types are provided in *AS1743 Road Signs - Specifications* and sign system planning and installation in the supporting document: *Austrroads Guide to Traffic Management Part 10: Traffic Control and Communication Devices*.

A.2 Bicycle Symbol

Every direction sign, single assembly of direction signs, free standing bicycle route marker or other navigational aid will include at least one bicycle symbol as shown in Figure C.26.

The overall height of the symbol will be as specified on the individual sign layouts detailed in *AS1743 Road Signs - Specifications*.

The bicycle symbol is available in electronic format, for accurate reproduction in sign design and manufacture, from Austrroads and state road authority websites.

Figure A.1: Bicycle symbol for use on bicycle directional signage

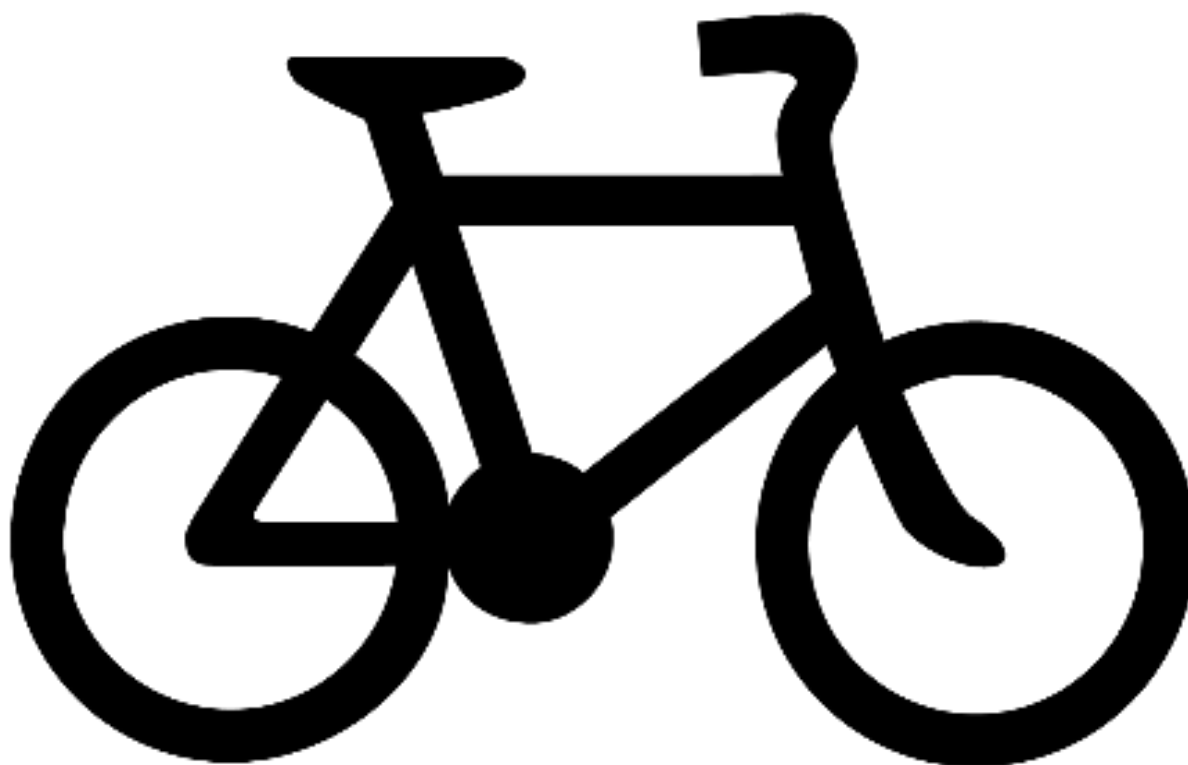

A.3 Colours and Reflectorisation

A.3.1 Colour

The following colour schemes are preferred for bicycle direction signs:

- Primary route signage and local route markers – a white bicycle symbol on blue background with all other lettering and symbols shown as blue on a white background;
- Local route signage – blue bicycle symbol, lettering, symbols and pictograms shown on a white background.
- Tourist/recreational route signage and route markers – a white bicycle symbol on a brown background with all other lettering and symbols shown as blue on a white background; and,
- Detour signage – the black bicycle symbol, lettering and symbols on a yellow background. The wording “Detour Route” when shown on signs will be white on a black background.

The following AS2700 colours are preferred for bicycle direction signs as listed above:

- Blue – AS2700 B23 Bright Blue;
- Brown – AS2700 X65 Dark Brown; and,
- Yellow – AS2700 Y15 Sunflower.

A.3.2 Reflectorisatation

Many cyclists, particularly those commuting to and from work, travel during dusk and dawn. Signs along commuter routes shall therefore use retro-reflective sign face sheeting material.

Whilst some bicycle headlamps may not be powerful, others are bright enough to illuminate well located retro-reflective signs. Also, there may be a substantial volume of motor traffic adjacent to, or crossing, bicycle commuter routes and car headlights will often illuminate the signs provided for cyclists.

Cycling network directional signs shall use a white retro-reflective background (Class 2 super engineering grade retro-reflective material) with AS2700 B23 Bright Blue colour lettering.

A.4 Direction Signs

Figure A.2, Figure A.3 and Figure A.4 show the layouts of bicycle directional signage for veloway/primary routes, local routes and tourist/recreational routes. Figure A.5 shows directional signs for long-term detour cycle routes. The planning, design, layout and dimensions for bicycle directional signage is specified in *AS1743 Road Signs - Specifications*.

The following are key requirements and recommendations for the design of direction signs:

- Destination names, distances and other directional information need to be easily read by cyclists when riding. The capital letter and the whole numeral height on bicycle directional signage are a consistent 60 mm high. Additional directional information (facilities and subsidiary routing information) when included as a second line on signs below the main destination, is 45mm high.
- Distance numerals when included on signs will be shown as follows:
 - Distance numerals are located between the direction arrow and the destination name.
 - Distances above 10km are rounded to the nearest kilometre.
 - Distances less than 10km are shown to the nearest 100 metres in standard decimal form to one decimal place.
 - Distances less than one kilometre are shown in metres (rounded to the nearest 100 metres e.g.: 300m). When listed on signs the numerals and the 'm' abbreviation (no space in between) are aligned-right with other destination numerals.
 - Distance numerals one kilometre and above are the same point size as destination names. Numerals for distances less than one kilometre are shown in metres and have a Capital X-height 75% of the height of whole kilometres.
 - Distance numerals are aligned on the decimal point.
- Directional indication will be by means of either chevrons, signs with pointed ends, or fully formed arrows as specified in the *AS1743 Road Signs - Specifications*.

Figure A.2: Primary bicycle route directional sign layouts



(a) FBP-2 Intersection fingerboard (two-lines, two destinations)



(b) DIP-2 Two-line Direction Indication sign - with distance numerals



(c) ADP-4 Four-line Advance Direction sign - used in advance of a cycle route junction, two primary routes shown. Horizontal line indicates a separate route



(d) RDP-4 Reassurance direction sign - used after a cycle route junction



(f) LSP Location sign (showing bicycle route on indicated road)

(e) MSP Map sign (showing area map with routes)

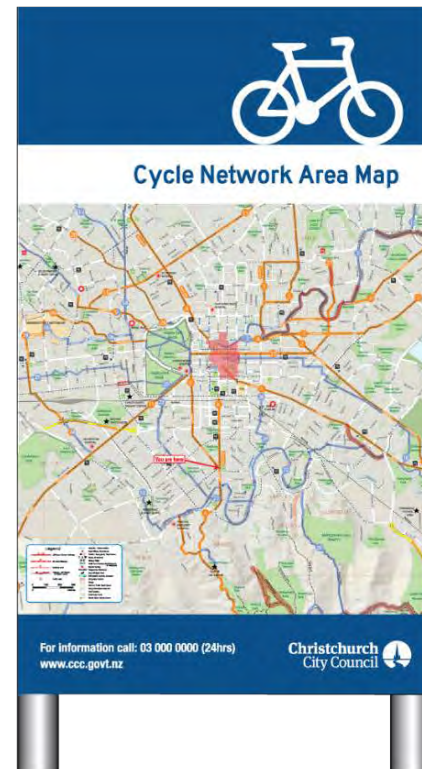

Notes

1. All signs are AS2700 B23 Bright Blue lettering/arrows on white retro-reflectorised background. Letter sizes as per AS1743 Road Signs Specifications – Appendix C Design and Layout of Cycle Network Direction Signs.
2. Typeface used for destinations/distances is AS1744:2015 Series D mixed capitals and lower case.
3. See AS1743 Road Signs Specifications – Appendix C Design and Layout of Cycle Network Direction Signs for individual sign layout drawings, dimensioning and full details on sign designs.

Australian Standard AS1742.9:2015

Velway and primary cycle route directional sign family – general sign types and layouts

Figure A.3: Local bicycle route directional sign layouts



(a) FBL-1 Local cycle route fingerboard with optional pictograms (max 6)
Mounted on same pole beneath street name sign.



(b) FBL-2PR Local cycle route fingerboard indicating a junction with a primary route
The end destinations of the primary route are shown on the lower line.



(c) FBL-2SD Local cycle route fingerboard indicating a main local destination and a secondary local destination
The main destination is shown in 60mm lettering. If the secondary destination was further along the local route than the main destination it would be shown in 45mm lettering and on the lower line similar to the (b) example above.



Local cycle routes are signed between junction fingerboard signs using route markers



(f) RML-V Local cycle route marker (vertical layout)

Single-sided marker shown mounted on separate steel or aluminium pole (or new or existing power pole)



RML-V Vertical route marker - direction variations



Notes

- All signs are AS2700 B23 Bright Blue lettering/arrows on white retro-reflectorisred background. Letter sizes as shown in AS1743 Road Signs Specifications – Appendix C Design and Layout of Cycle Network Direction Signs.
- Typeface used for destinations/distances is AS1744:2015 Series D mixed capitals and lower case.
- Local route signs are square ended with directional arrow reproduced to dimensions as per AS1743 Road Signs Specifications – Appendix C Design and Layout of Cycle Network Direction Signs.

Australian Standard AS1742.9:2015

Local cycle route directional sign family – general sign layouts

Figure A.4: Tourist/recreational bicycle route directional sign layouts

Tourist/recreational route fingerboards

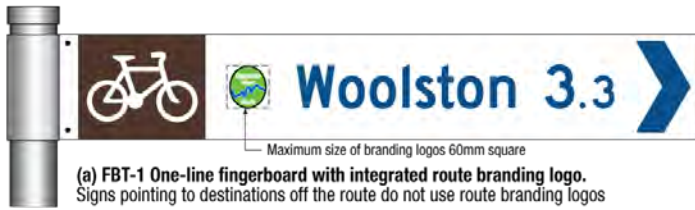

Tourist/recreational route facilities indication fingerboards



Notes

1. All signs are AS2700 B23 Bright Blue lettering/arrows on white retro-reflectorised background with a white bicycle symbol on a square brown background at the mounting end of each sign. Brown colour is AS2700 X65 Dark Brown. Letter sizes as per AS1743 Road Signs Specifications – Appendix C Design and Layout of Cycle Network Direction Signs .
2. Typeface used for destinations/distances is AS1744:2015 Series D mixed capitals and lower case.
3. Tourist/recreational fingerboards are square ended with directional arrow reproduced to dimensions as per AS1743 Road Signs Specifications – Appendix C Design and Layout of Cycle Network Direction Signs.
4. Horizontal type markers are double-sided. Vertical markers are single-sided mounted on new or existing poles.

Tourist/recreational route route markers



Route marker for on-road training routes



Australian Standard AS1742.9:2015

Tourist/recreational cycle route directional sign family – general sign layouts

Figure A.5: Detour and special purpose bicycle directional sign layouts



(a) FBD-1 One-line fingerboard for long-term detour route - layout template



(b) FBD-2 Two-line fingerboard for long-term detour route - layout template



(c) FBD-2RN Two-line fingerboard for long-term detour route with numbering- layout template

Long-term route detour sign notes

1. Signs are black lettering/arrows on AS2700 Y15 Sunflower retro-reflectorised background. Letter sizes as shown in *AS1743 Road Signs Specifications – Appendix C Design and Layout of Cycle Network Direction Signs*.
2. Typeface used for destinations/distances is AS1742:2015 Series D mixed capitals and lower case. Typeface for Detour Route box is AS1742:15 Series D all capitals.
3. Fingerboard lengths and direction indication sign widths to suit length of lettering and other sign content elements.
4. Fingerboards fabricated with 5mm radii on protruding corners. Direction indication signs fabricated with 5mm radii on all corners.

Australian Standard AS1742.9:2015

Route detour signs – general sign layouts



(d) DID-2 Two-line direction indication sign for long-term detour route - layout template

Arrow and symbol combination centred in width of sign



(e) DID-1 One-line direction indication sign for long-term detour route - layout template



DID-1LT Left-turn arrow



DID-1RT Right-turn arrow



DID-1VL Veer-left arrow



DID-1VR Veer-Right arrow

(f) DID-1 Direction indication sign - direction variations

Appendix B Recommendation for Austroads Guide to Traffic Management Part 10

B.1 Introduction

The active transport and recreational needs of communities are efficiently served by the development of regional and local networks of interconnected cycling routes linking major trip origins to destinations. The planning of these networks is undertaken by relevant government agencies and local governments as part of regional and municipal bike plans.

Directional signs provide wayfinding and informational guidance for cyclists across these cycle networks. These guidelines deal only with directional signs for cycling routes (both on- and off-road) within a cycling network. They do not cover the many other aspects of cycling network facilities signs and marking, such as regulatory and warning signs, linemarking, regulatory pavement symbols and behaviour signs for which there are separate guidelines (see Table B.1:).

Table B.1: Reference documents for cycle network signs

Reference type	Guidelines documents (primary references first)
Regulatory, warning, advisory and directional signs. Linemarking and pavement symbols	<i>Australian Standard AS1742.9:2015</i> <i>Manual of Uniform Traffic Control Devices Part 9 Bicycle Facilities.</i> <i>NZ Traffic Control Devices Manual</i> <i>Part 2: Direction, Service and General Guide Signs.</i> Relevant jurisdictional guidelines.
Design, layout and dimensioning of individual directional signs	<i>Australian Standard AS1743 Road Signs – Specifications.</i>
Directional sign planning, installation guidance and resources	<i>Austroads Guide to Traffic Management Part 10: Traffic Control and Communication Devices.</i> <i>Queensland Transport and Main Roads (QTMR)</i> <i>A Guide to Signing Cycle Networks.</i> (Available for download from the QTMR website: www.tmr.qld.gov.au)

These guidelines are designed to assist road designers, engineers and transport planners to provide high quality, professional and consistent directional signs for cycle networks across Australian and New Zealand (ANZ) cities and towns. Directional signs enable riders to use cycle networks to their full potential and make quick and accurate route choices.

These guidelines provide guidance and advice on the following issues:

- Planning a directional sign system (focal point mapping, destination and decision points);
- Route hierarchy and the types of signs appropriate for each type of route in the cycle network;
- Facility naming, route numbering and route branding;
- Location and mounting of signs; and,
- Special sign situations such as marked detour routes, tourist destinations and routes through complex intersections.

The purpose of the signs described in these guidelines is to provide wayfinding and directional assistance for cyclists using routes which comprise a wide range of facilities, some of which may be shared with motorists or pedestrians. Directional signs have no regulatory purpose or intent and do not imply an exclusive use by cyclists of paths shared with pedestrians or streets shared with drivers. In practice, care should always be taken to ensure that directional signs are fully supported by the appropriate regulatory signs relevant to the street/path facilities that comprise the cycle route.

In the interests of uniformity, local governments and private sector large scale landowners are encouraged to apply these guidelines when installing directional signs for cycling route facilities on streets, roads and paths under their control. To assist cycle network providers with the implementation of these guidelines, the Queensland Transport and Main Roads resource manual, *A Guide to Signing Cycle Networks*, is recommended. This publication contains additional information and advice on the practical aspects and processes involved in the installation of cycle network directional sign systems.

B.1.1 Application of these guidelines

These guidelines are intended to supplement guidance on directional signs for cycling networks described in Section 5 of Australian Standard *AS1742 – Part 9: Bicycle Facilities*, Australian Standard *AS1743 Road Signs – Specifications* and the *NZ Traffic Control Devices Manual Part 2: Direction, Service and General Guide Signs (TCDM-2)*. These guidelines replace directional sign guidance previously provided in Austroads Guides and are intended to provide uniform guidance for Australian and New Zealand jurisdictions. In each jurisdiction additional guidelines supplements may apply and practitioners should consult these in their area to determine the most appropriate sign implementation.

B.1.2 Signing routes with and without cycle infrastructure

Cyclists are legally defined as vehicles and can use public roads unless specifically prohibited for operational safety reasons (e.g.: urban motorways). The lack of cycling infrastructure along a route, such as cycle lane markings, regulatory and warning signs and bicycle pavement symbols, does not necessarily mean that the route is unsuitable for cycling. Cyclists have differing levels of competency and sensitivity to traffic. Experienced cyclists will often prefer unmarked wide kerb-side traffic lanes to marked cycling/car parking lanes due to their close proximity to opening car doors. Others (such as children, new adult riders and the elderly) may prefer to avoid trafficked roads altogether and ride off-road.

Fitting a route with a system of directional signs provides all cyclists with important wayfinding information which helps them to more effectively use their bicycles for a wide range of local and regional trips. Without these signs it is difficult for them to take full advantage of the road system and to use their bicycles as an efficient means of transport.

On routes where off-road cycling facilities are provided, the needs of on-road cyclists are always considered. This may often mean the installation of additional signs at junctions or turning points to address the separate cycling travel paths of each user group.

B.2 Sign designs

There are eight types of cycle directional signs and a set of directional pavement indicators used on cycle networks. Each route type has its own family of signs consisting of some or all of these sign types. Pavement markings can be used on all route types for wayfinding guidance.

B.2.1 Fingerboards

Fingerboards are double-sided direction signs used at intersections and route turnings to show the way to destinations further along the route. When fingerboards are located at junctions with other routes they also show distances to the destinations shown on the sign. Fingerboards are used to mark all route types.

Figure B 1: Fingerboard sign example



B.2.2 Direction indication signs

Direction indication signs are used in place of fingerboards where that type of sign cannot be used due to siting/mounting or legibility issues. Direction indication signs can show destinations only (at turning points) or destinations and distances (at junctions with other routes). Direction indication signs are used on veloways and primary routes.

Figure B 2: Direction indication sign example



B.2.3 Advance direction signs

Advance direction signs are used to indicate the destination choices in advance of a route junction. They are used on veloways and primary routes at junctions with other veloways or primary routes. They can be used on veloways or primary routes at junctions with local or tourist/recreational routes if those routes are of importance and connect to a major trip attractor relevant to cycle traffic on the primary route.

Figure B 3: Advance direction sign example



B.2.4 Reassurance Direction signs

Reassurance direction signs are used following route junctions on veloways and important primary routes to reassure cyclists that they are following the correct route. These signs also indicate the distances to multiple destinations on the route being followed. They are usually only used on high-speed, limited-access veloways but can be used on important primary routes if reassurance is needed due to complex navigational situations.

Figure B 4: Reassurance direction sign example

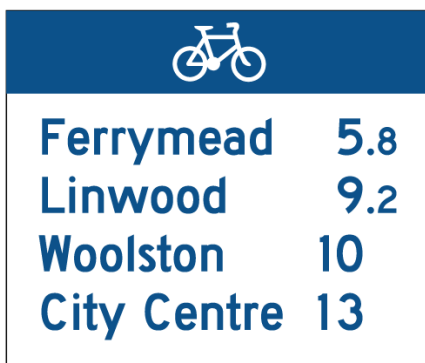

B.2.5 Location signs

Location signs are used at underpasses or bridges over a cycle route to identify cross streets/roads which are not otherwise signed due to the remoteness of the site. Location signs can be used on all types of route.

Figure B 5: Location sign example



B.2.6 Facilities/services signs

Facilities/services signs are simple one-line fingerboards used to indicate nearby facilities and services easily accessible from a route. These signs can be used on all types of route.

Figure B 6: Facilities/services sign example



B.2.7 Route markers

Route markers are simple direction arrow signs used to indicate route turns in place of other types of directional signs. Route markers are used on local and tourist/recreational routes to indicate route turnings in between junctions with fingerboards. They are not used on veloways and primary routes. Direction indication or fingerboards should be used on these routes.

Figure B 7: Route markers sign example



B.2.8 Map signs

Map signs are used on veloways and primary routes to provide additional wayfinding information to cyclists such as other routes and destinations within an area covered by a network map. Map signs can be used on veloways, primary and tourist/recreational routes.

Figure B 8: Map sign example

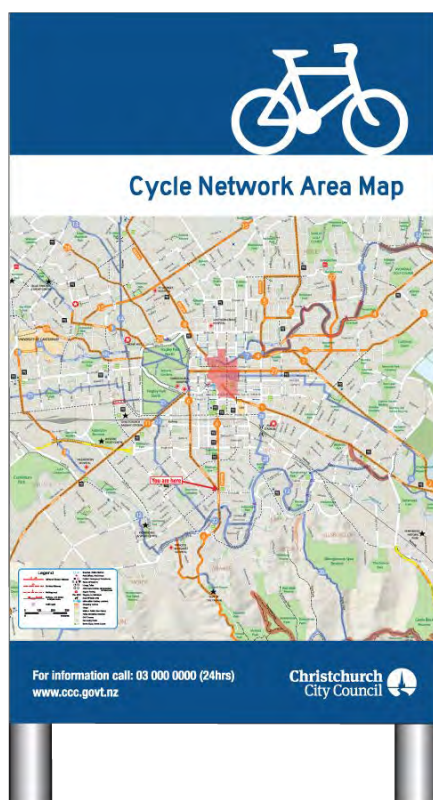

B.2.9 Project signs

Project signs are used on cycle facilities to provide information about new/changed cycleway and shared path infrastructure projects. Project signs are usually erected following the announcement of a project and can remain in position for up to two years after completion to highlight the public investment in the new infrastructure. Figure B.6 shows an example of a project sign used on a cycle network project. The advice of the funding agencies is sought on the sign design applicable to each project. Project signs for cycle network infrastructure projects are no larger than 3x2.4m and should comply with government approved designs and jurisdictional guidelines.

Project signs shall meet the following objectives:

- Communication of critical project information;
- Identification of the funding authority; and,
- Delivery date.

Project signs may additionally list the following:

- Future planned infrastructure details;
- Funding scheme (if applicable); or,
- Cycle network infrastructure funding agency additional involvement.

Figure B 9: Map sign example

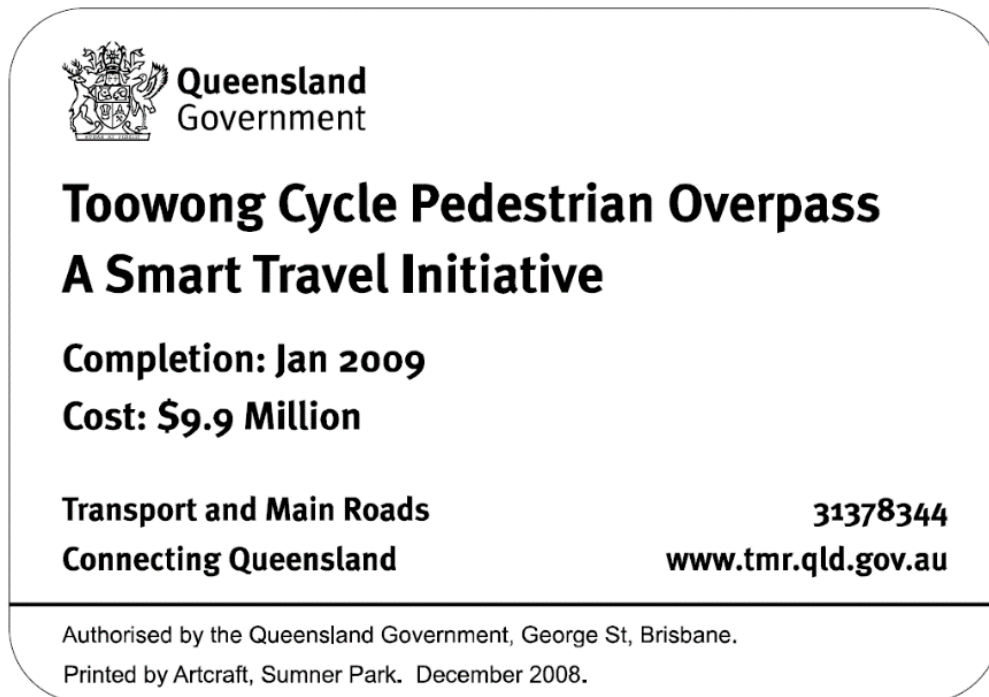

B.2.10 Directional pavement markings

Route directional pavement markings indicate on-road route turnings to warn cyclists of on- to off-road transitions which may be difficult to see from a distance or at speed. Directional pavement markings are a useful aid to navigation and provide an important supporting role to signs. Directional pavement markings can be used on all types of route as an aid to navigation.

Figure B 10: Directional pavement example

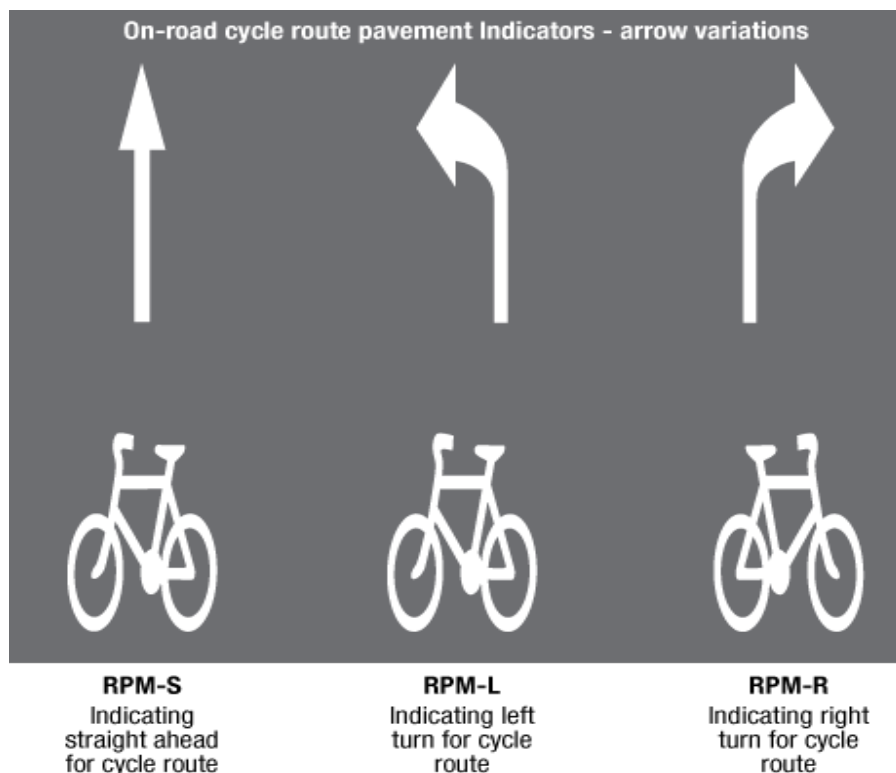

B.3 Cycle route types

Cycle networks consist of four distinct route types: primary; local; tourist/recreational; and, long-term detours. Each route type (see Table B.2) uses a different combination of sign types appropriate to the needs of the route within the overall network hierarchy. Design details for each sign family, including sign variations and recommended usage, are provided in the following subsections of these guidelines.

The number and location of directional signs provided for each route (as detailed in Table B.3) allows for a degree of redundancy in the sign system. A sign system with only one sign at each route junction risks a breakdown or 'break in the chain' of important wayfinding information for the user. If one sign is removed the system fails. Only local routes leading directly to destinations over shorter distances have one sign per intersection.

Table B.4: Cycle routes and the sign types used on each route type

Sign Types	Route Types				
	Veloway	Primary	Local	Tourist / Recreational	Detour
Route type description	High-speed, limited-access routes usually paralleling major arterial roads or motorways	The main arterial routes of urban cycle transport networks	Shorter routes connecting primary routes to local destinations	Off-road, shared path and tourist / recreational routes	Long-term detour routes for veloways, primary or tourist / recreational routes.
Fingerboards	Yes, at junctions with other routes and where the route changes direction	Yes, at junctions with other routes and where the route changes direction	Yes, integrated with street signs	Yes	Yes
Direction indication signs	Yes, at junctions with other routes and where the route changes direction	Yes, at junctions with other routes and where the route changes direction	No, use markers instead	No, use markers instead	Yes
Advance direction signs	Yes, before route junctions with veloways or primary routes	Yes, before route junctions	No, use markers instead	No, use markers instead	No
Reassurance signs with distances	Yes, after route junctions with other veloways or primary routes	Only on lengthy remote routes for reassurance	No, use markers instead	No, use markers instead	No
Route markers	No, use direction indication signs	No, use direction indication signs	Yes	Yes	No, use direction indication signs
Route numbering	Yes	Yes	No	Yes	Yes, if route replaced by detour is already numbered
Route branding	Yes	Yes	No	Yes	No
Street signs	Yes, if none exist	Yes, if none exist	Yes, if none exist	Yes, if none exist	Yes, if none exist

B.3.1 Veloway and primary routes

The veloway and primary route sign family consists of a full range of sign types for use on routes which perform the most important transport functions in the cycle network.

Primary routes are the core of the cycling network. Primary routes are high-priority routes providing quick, direct travel between the major centres within a city and to key centres within the surrounding region. These routes offer the most direct path of travel and minimal delays. Primary routes are referred to in different jurisdictions as principal, regional or main routes. In these guidelines they are only referred to as primary routes.

Though most urban cycle networks use a two-level hierarchy of primary and local routes, in some cities higher-grade routes are being developed. These are usually high-speed limited-access routes such as urban 'veloways' or 'cycling super highways'. In recognition of the higher operating speeds this type of route is signed with the highest level of signing with reassurance direction signs used at route junctions in addition to fingerboards and advance direction signs. Signs on this type of route are always sited to adequately provide for higher-speed travel.

Figure B 11: Types of signs used on veloways and primary routes

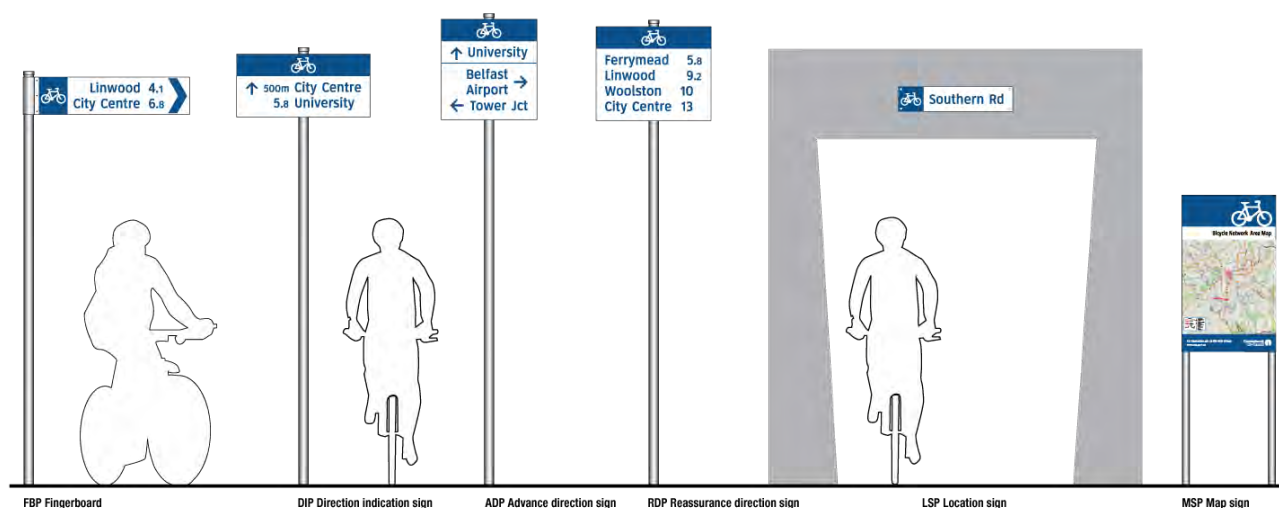

Veloway and primary routes use the following sign types (see Figure B.11):

- **Fingerboards** indicate the way to destinations listed on the signs. When fingerboards are used at route junctions distances to destinations are shown. When used along a route to indicate a change of direction only, distance numerals are not used. Fingerboards usually indicate a single route except in situations where routes overlap for a complete route sector (between focal points). In these rare instances both routes have the same destinations so only one set of fingerboards need be used. In cases where two overlapping routes share the same sub destination but have different focal points, a three-line fingerboard can be used.
- **Direction indication signs** are used in place of fingerboards at intersections and route turnings where it may be difficult to site a fingerboards or where sign legibility of is compromised. As with fingerboards, direction indication signs show destinations for a route and the same rules apply for instances of overlapping routes.
- **Advance direction signs** show focal point destinations for all routes passing through a route junction in advance of that intersection. Sub destinations are not shown on these signs. Advance direction signs never show distances. The Graphical layout advance direction sign is a sign variation used in advance of complex route junctions where it is necessary to indicate recommended cycle routes through the intersection. This may involve off-road to on-road transitions through multi-legged intersections often with traffic islands, signalised crossings and divided roadways. Graphical layout type signs can also be used in place of direction indication signs at route turnings in complex traffic environments.

- **Reassurance direction signs** are used following route junctions to provide reassurance to cyclists that they are on their chosen route. They can also be used in between route junctions on lengthy routes with few intersections to provide reassurance and distance information. Reassurance direction signs list the next sub destination, focal point destination and other subsequent focal points or terminal destination for a route. Reassurance direction signs are rarely used on primary routes. They may be used to provide additional reassurance on remote routes with few intersecting route junctions and on important main routes linking major centres.
- **Location signs** are used where a route passes under a significant road or cross street. Location signs are not used to mark junctions with other routes – fingerboards are used at these junctions. Location signs only list the names of cross streets/roads and do not show distances or direction arrows. In rare cases a direction arrow may be used as a further aid to route navigation where the associated underpass has a bend in the path direction or change of grade. There are two types of location signs, the type A sign which is used to mark a cross street which carries a cycle route that is part of the cycle network, and the type B sign which is used to indicate cross street which is not part of the cycle network. Location signs can be used for veloway, primary and tourist/recreational routes. They are used on local routes only where the cross street or road is a primary cycle route.
- **Map signs** show a detailed street map with a recommended coverage of approximately 6 x 6km. The map includes cycle routes for that area superimposed on the base map in an easy to read colour or line type. The map is centred on the physical site of the sign. A “You are here” marker indicates the sign location on the map. Significant trip attractors that exist outside the map area are marked with text and an arrow indicating the direction of the facility or destination (e.g. City 4km). Map signs for on-road routes are sited in an off-road viewing bay or in parklands adjacent to the street being followed. Map signs ideally are located to allow path users to view the map when facing in a northerly direction to facilitate easy map orientation (if a north-oriented base map is used). When siting map signs adjacent to paths and off-road bikeways where no viewing bay is provided, map signs are located at least one metre from the path edge to ensure there is sufficient space to move off the path to read the sign and not create a hazard for other path users. To indicate desired/safe rest stops along shared paths and cycleways, the location of map signs, where appropriate, can be co-located with other path infrastructure such as seats, lights, racks, shelters etc. The location of signs in lit areas is recommended to extend the functional hours the signs are usable. Information signs are variations of map signs which incorporate maps, photographs and illustrations in addition to explanatory text.

B.3.2 Local cycle routes

Local cycle routes link the primary route network to residential streets and localised trip-generating facilities such as schools, bus and train stops/stations, and major local community facilities. Local routes provide access by bicycle within a city town or suburb. Local routes often use shared paths either through parklands or off-road within road corridors.

Importance of street name signs on local routes

Though street name signs do not form part of the cycle network sign system, it is vital for cyclists that they can use clearly legible street signs at every route turning/intersection to enable them to navigate and reach their destination as quickly as possible. This is an important wayfinding consideration for all types of routes but it is particularly important for local routes as these routes use markers (without destination names) for most of their route length.

When the installation of a new local route sign below a street name sign reduces clearance to less than 2.5m, alternative provision has to be made. This may include re-installation of the existing street name sign on a new taller pole.

Figure B 12: Types of signs used on local routes

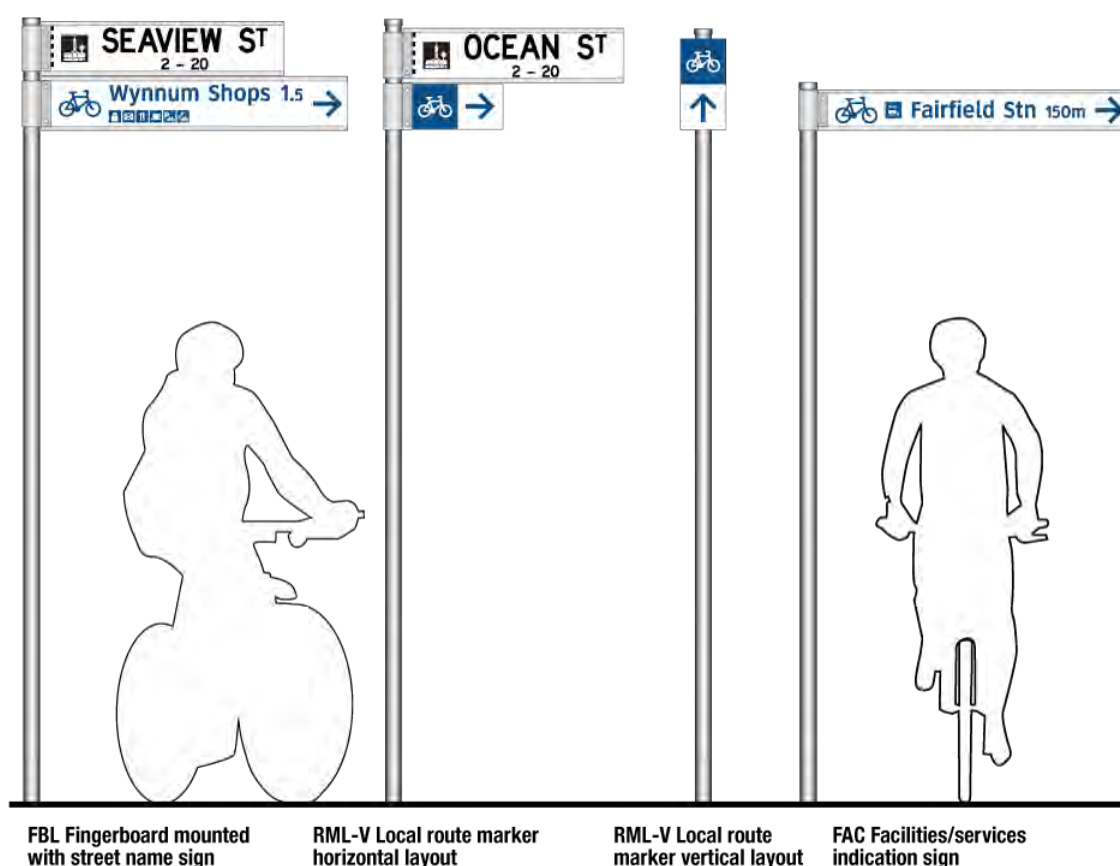

Local cycle routes use the following sign types (see Figure B.12):

- **Fingerboards** indicate a single route and are placed at each end of a local route: (a) where it branches from a primary route; and, (b) at its destination facing back along the route in the opposite direction.
- **Facilities/services fingerboards** are used on paths through parklands and reserves to indicate facilities such as water points, toilets, information centres and points of interest. These destinations are important to recreational cyclists and tourists and are a key inclusion in any sign plan associated with tourist and recreational routes. Facilities/services fingerboards can be used on all route types to indicate nearby services and facilities of use to cyclists.
- **Local route markers** are used to supplement local route fingerboards at route turnings and to provide reassurance. There are two types of local route markers: horizontal-layout, double-sided markers designed to mount on poles as mini-fingerboards; and, vertical-layout, single-sided plate-type markers designed for pole mounting. Route numbering and branding is not used on local route markers.

B.3.3 Tourist / recreational cycle routes

Tourist and recreational routes are specially developed to provide recreational and tourist cycle access within a city, or a region, or in a rural setting. Examples of such routes are rail trails (built along disused rail corridors), coastal trails, lake- and river-side paths and historical trails. Tourism and recreational routes are usually developed in conjunction with city and/or regional tourism organisations.

Figure B 13: Types of signs used on tourist / recreational routes

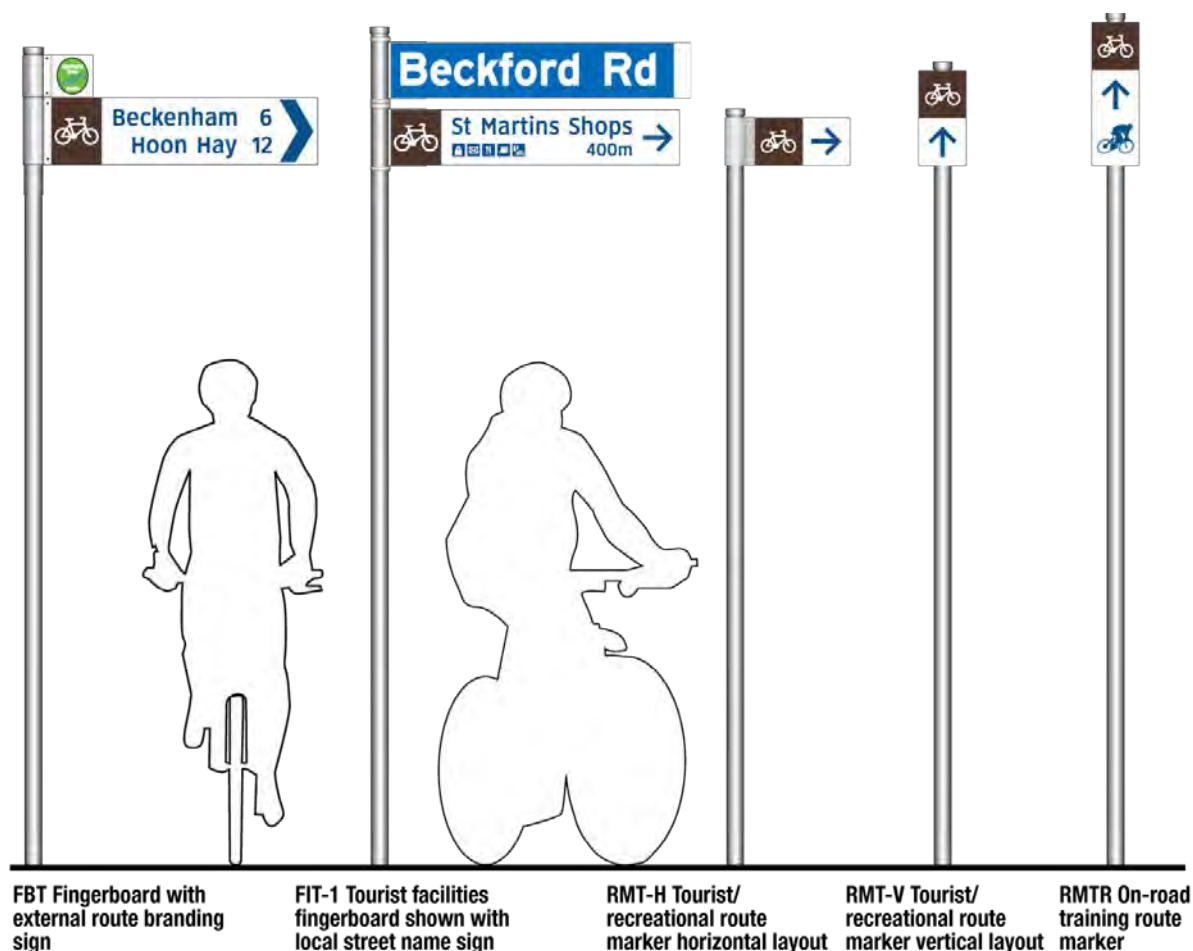

Tourist/recreational cycle routes use the following sign types (see Figure B.13):

- **Route fingerboards** are similar in design to primary route fingerboards but use a brown coloured patch in conjunction with the white bicycle symbol to indicate the tourist/recreational nature of the route. Fingerboards indicate a single route and are used at route junctions and route turnings to indicate travel direction. Distances to destinations are only shown when used at route junctions. When used along a route to indicate a change of direction only, distance numerals are not used.
- **Facilities fingerboards** indicate facilities and points of interest to route travellers. These could be historic sites, attractions, accommodation and other relevant tourist services. Route naming, numbering and branding is not usually used on this sign type.
- **Tourist / recreational route markers** are used to supplement fingerboards at route turnings and to provide reassurance. There are two types of tourist/recreational route markers: horizontal-layout, double-sided markers designed to mount on poles as mini-fingerboards; and, vertical-layout, single-sided plate-type markers designed for pole mounting.
- **On-road training route markers** are designed for use on a specially identified fitness and training route for on-road cyclists in normal traffic conditions. These signs may simply identify the popular fitness/training routes preferred by road cyclists and in some cases may be used by cycle clubs for organised cycling sporting events with event permission.

B.3.4 Detour routes

Detour routes are specially identified (on- or off-road) to provide alternative access while part of an established cycle route is closed due to construction. Detour signs are typically only installed when the route closure is in place for an extended period of time. For temporary closures, standard temporary warning/construction signs are used. Detour signs are planned and installed to integrate seamlessly with existing cycle route signs using the same destinations as on existing signs.

Figure B 14: Types of signs used on detour routes

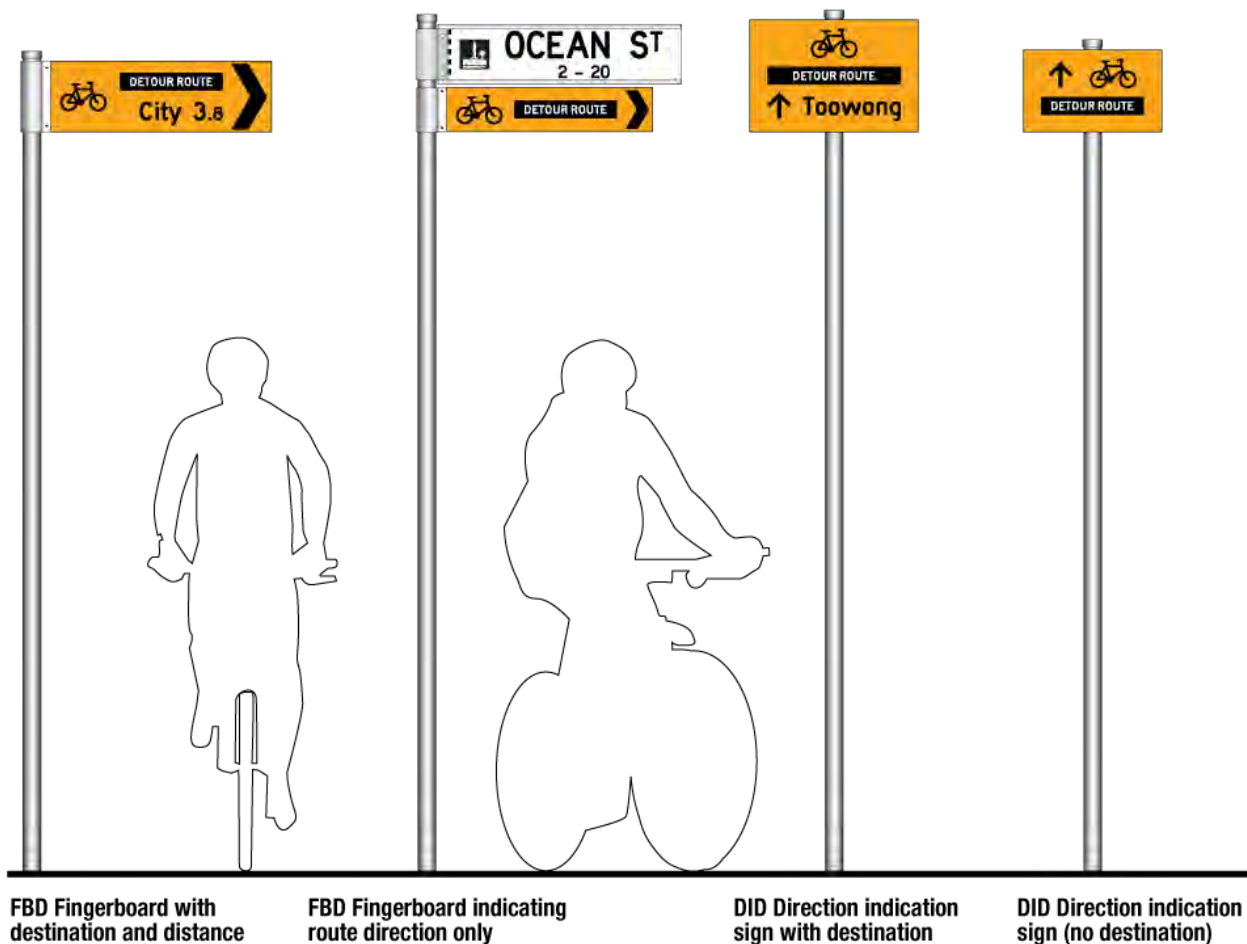

Detour routes use the following sign types (see Figure B.14):

- **Fingerboards** indicate a single detour route and contain the lettering “DETOUR ROUTE”. They are used to show the direction of travel on the detour. When fingerboards are used at route junctions, destinations and distances are shown. When used along a route to indicate a change of direction only, distance numerals are not used. Fingerboards without destinations can also be used as a direction indicator at route turnings.
- **Direction indication signs** are used in place of fingerboards at intersections and route turnings where there are siting difficulties or the legibility of fingerboards is compromised. As with fingerboards, direction indication signs can show destinations for a route and only show distances when used at route junctions.

B.4 Developing a directional sign plan

The methodology recommended in these guidelines for planning and implementing cycling sign projects is similar to other transport systems such as highway and arterial road signs. A key requirement is that routes are planned and signed within the context of the surrounding regional cycle network. This planning enables routes to be fully signed indicating the full range of destinations available across a region rather than within a narrow corridor.

The following steps for developing a directional sign plan are outlined in the following sections:

1. Document the current (and planned) cycle routes (see B.4.1).
2. Create (or update) the focal point map for the region (see B.4.2).
3. Document any facilities which will need to be named on signs (see B.4.3).
4. Document any route numbering which will be required on signs (see B.4.4).
5. Document any route branding which will be required on signs (see B.4.5).
6. Conduct a pre-sign, risk assessment survey (see B.4.6).
7. Document all junctions with other routes (see B.4.7).
8. Prepare a sign schedule covering the route (see B.4.8).
9. Prepare a sign artwork files for the sign manufacturer (see B.4.9).

B.4.1 Identify cycle routes

When considering cycling routes for sign projects, it is essential to differentiate between cycle routes and cycling facilities. Cycle routes are continuous connections which facilitate travel within an area served by the cycling network. Each cycling route can consist of many types of cycling facilities from on-road lanes and separated off-road cycleways within the road corridor to low-traffic volume local streets with little or no linemarking or explicit cycling facilities.

The lack of defined regulatory cycling facilities and engineering treatments such as bicycle lanes and paths should not prevent the installation of directional signs along a designated route providing that the usual road safety and traffic management practices are followed. A cycle route only has to be assessed as legally rideable for it to be considered for signing.

The planning phase for signing cycle networks and their component routes is only concerned with cycle routes. The type and existence of cycling facilities is a key consideration in the implementation phase of a sign project, as the precise siting of any directional signs shall be directly influenced by the facilities present.

The first stage in developing a sign plan for a route or routes is to identify all interconnecting cycle routes and the destination names (focal points) used on these routes which should be included on signs. For example, at a junction of two primary routes, the advance direction signs on each approach will list the next focal point for the route being followed and those for each intersecting route. At route junctions, fingerboards for other intersecting routes are usually installed at a later stage when the full sequence of signs for those routes are being installed.

B.4.2 Create a Focal Point Map

When planning and designing directional signs for cycling routes utilising a network approach, designers first need to determine the destination points and decision points (route junctions) for each route within the network. These details can then be used for single- or multiple-route sign projects. The key tool for the coordinated development of directional sign systems for cycling is the Focal Point Map for a region.

A focal point map is a planning document used by the cycle network's manager to establish the destinations which appear on directional signs for the network. A key aim of a cycle network focal point map is to achieve rigid consistency in the use of named destinations so that a coherent system of signs can be developed to enable direct and unambiguous navigation around the cycle network. Only those destinations appearing on the focal point map are used on cycle network signs.

This map is usually maintained by a government authority responsible for the regional cycle network. This could be a centrally located council working in consultation with the government road authority and neighbouring councils. As cycle networks are locally- or regionally-based and are more fine-grained and urban-oriented than the main road network, they may use different focal points to highway/arterial road focal point maps within the same area or region.

Figure B.15 shows an example of a focal point map for an urban regional cycle network for the Sydney inner-city area. The map shows primary cycle routes identified in the Inner *Sydney Regional Network Bike Plan* and council bike plans. The following guidelines apply to focal point mapping methodology for cycle networks:

- Focal points are significant destinations within a region where routes join, cross or terminate. Focal points are indicated in the focal point map by a solid disc symbol. At complex junctions where routes overlap or cross, small red arrows are sometimes used on the map to clarify the paths for each route. For a fine grained urban cycle network, it is recommended that focal points be spaced at approx. 5km.
- Terminal destinations are focal points where routes terminate. This may lie beyond any junction with another route or where a route terminates by joining another route at a T-junction etc.
- Sub destinations are important intermediate centres along a route. To keep sign content compact, only one sub destination is listed with the next focal point destination until the sub destination is reached.
- In areas where a focal point is needed but is not immediately apparent, the focal point map designer consults with stakeholders to determine the most appropriate destination name to include on route direction signs.
- City centre focal points are used in large and complex metropolitan CBDs where many routes converge but do not intersect neatly at a single junction. A city centre focal point is usually defined as a small area encompassing all route junctions with a compact geographical area. Primary routes leading to the city centre are considered to have reached the city centre when they reach the defined boundary even though this may be a distance from the actual geographical centre of the city. The destination wording (used for the particular city centre) should continue to be used on signs between the boundary edge and the geographical centre. It is usual practice to list any destinations on the opposite side of the city centre which that route may connect with and continue onto. This practice further assists with route finding within a complex area.

Table B.3: Destination definitions for focal point cycle network mapping





Location type	Symbol	Definition
Focal point destinations		Major cities, towns, regional centres and key suburbs located at or near the junction of primary cycle routes.
Terminal destinations		Cities, towns, city/town centres, regional centres and major localities which are located at the ends of primary cycle routes but are not at a junction with other primary routes.
City centres		The city centre area where many routes converge and intersect but not at a single junction. The City Centre may be defined as an area containing multiple route junctions.
Sub destinations		An important intermediate locality listed on the sign which is reached in advance of the route's next focal point.
Local Destinations		Important local trip generators located at the termination of local routes (sporting/recreational and entertainment venues, community facilities, key local attractions and points of interest etc) (for clarity, these are not shown in Figure B.15)

Figure B 15: A section of the Inner Sydney Regional Cycle Network Focal Point Map



B.4.3 Identify any named facilities

Veloways, primary and tourist/recreational cycle routes may occasionally use all, or sections of, path facilities which have been named by a local council or government agency. The use of cycle facility names on cycle route signs should be kept to a minimum as it can place heavy demands on available sign space often increasing the physical size of signs and does not necessarily improve wayfinding.

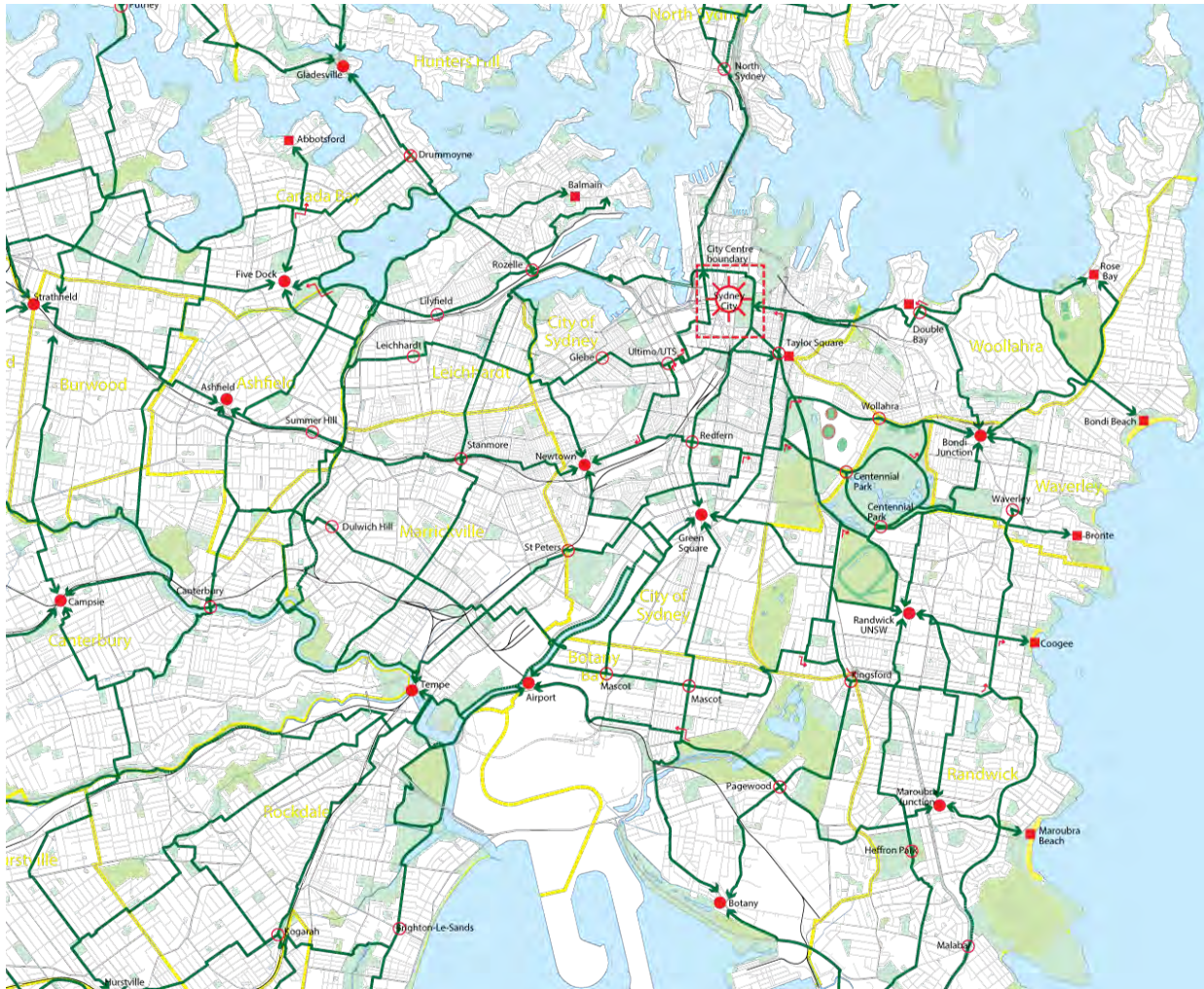
Veloway and primary route signs can include facility name indication as follows (see Figure B.16):

- Facility name indication is limited to the start and finish of the named facility or at junctions where other primary routes enter the facility.
- The length of a facility name sign or integrated facility name box should not exceed the length of the associated route sign. Lengthy facility names are abbreviated or the facility name shown using the more condensed AS1744:2015 Series C typeface.
- On veloways and major primary routes, the names of significant intersecting streets/roads (route exit points) may be shown on signs using a similar layout.

Figure B 16: Examples of direction signs for named facilities

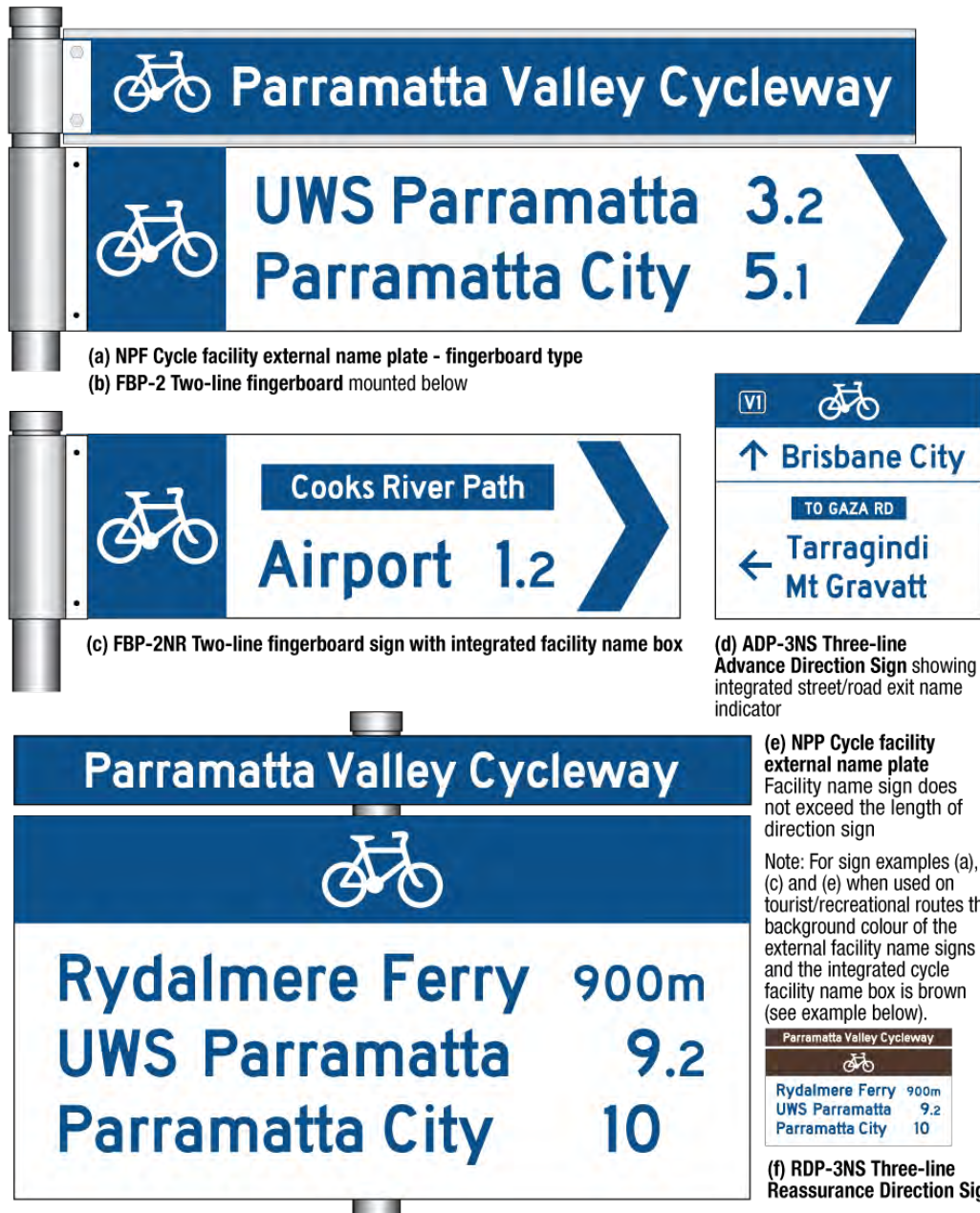

B.4.4 Identify any numbered routes

In densely populated cities where there are far more route options than in smaller centres, route numbering may make it considerably easier for users to navigate their way around the cycle network. Route numbering may also be appropriate on longer distance (inter-city) routes as numbered routes can extend across an entire metropolitan or city area.

Adoption of a system of cycle route numbering is sanctioned by the appropriate authorities responsible for the cycle network within a city, region or state. Planning and maintenance of the cycle route numbering system is the additional responsibility of an inter-governmental group or agency/jurisdiction which maintains the Focal Point Map for the cycle network within that city/region. If route numbering is sanctioned, the numbering system is applied consistently on all network directional signs within the region.

There are three levels of numbered routes recommended:

- **Alpha-numeric numbered routes** (white letter/number on a blue background). These are usually higher-speed, limited access veloway routes or 'cycling super highways' offering the highest quality level of service and access to urban centres for cyclists. This type of route uses an alpha-numeric code comprising the letter 'V' (for veloway) followed by the route number in the series. The use of this type of route numbering is limited to a small number cycle routes within a capital city or between cities within a densely populated region (such as the V1 in Southeast Queensland which links Brisbane to the Gold Coast using the M1 and M3 Motorway corridors).
- **Two digit numbered routes** (white numbers on a green background). These routes are the core primary routes for the metropolitan cycling network providing continuous cycle travel between major urban centres.
- **Three digit numbered routes** (white numbers on a dark brown background). These routes are major urban or rural tourist/recreational facilities providing a continuous route throughout the region. Examples of this type of route are: lengthy and continuous urban recreational routes, rural rail trails, urban on-road training routes, and long distance rural routes on- and off-roads.

Veloway, primary and tourist/recreational route signs can include route numbering indication as follows (see Figure B.17):

- Route numbering can be used on signs and markers.
- Route numbers can be associated with a single destination, a group of destinations or a route.
- Route numbering and route branding are separate systems with potentially overlapping segments. The examples in Figure B 18 show fingerboards with three overlapping routes (26, 146 and a branded route).

Figure B 17: Examples of direction signs with route numbering

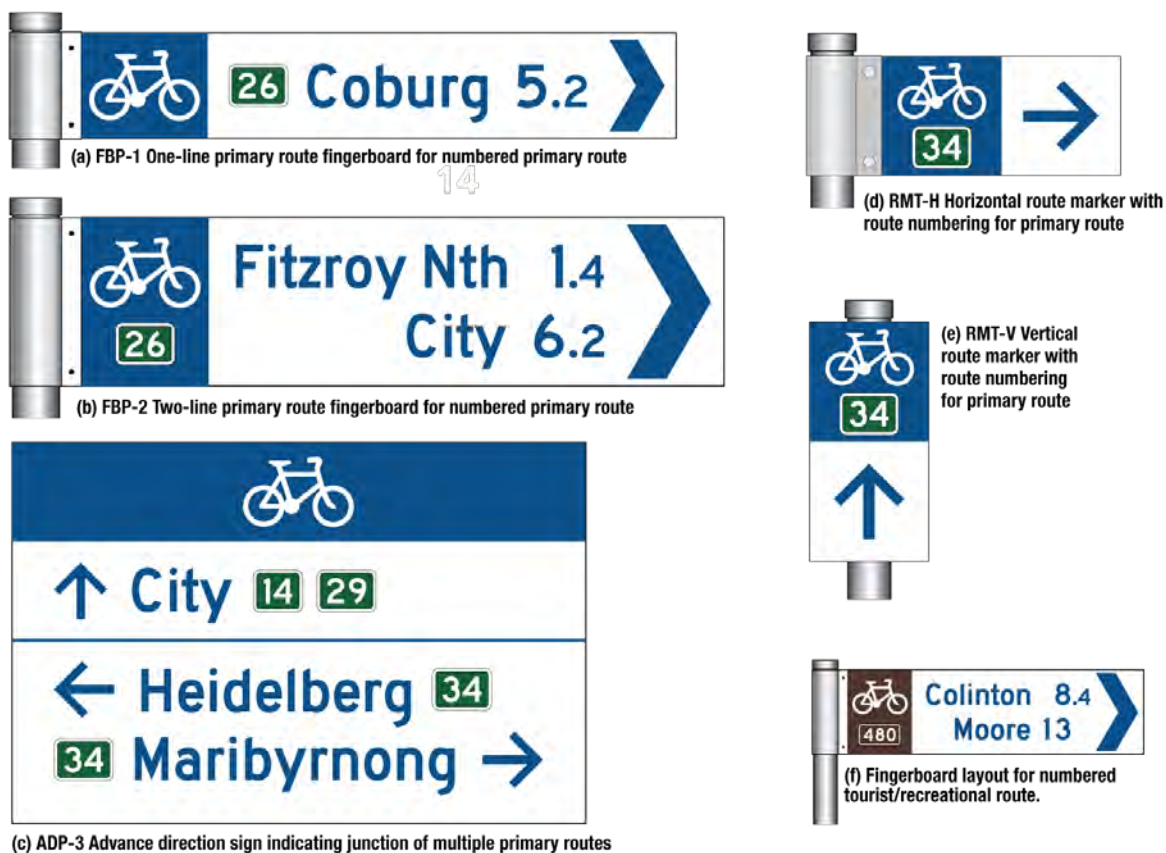
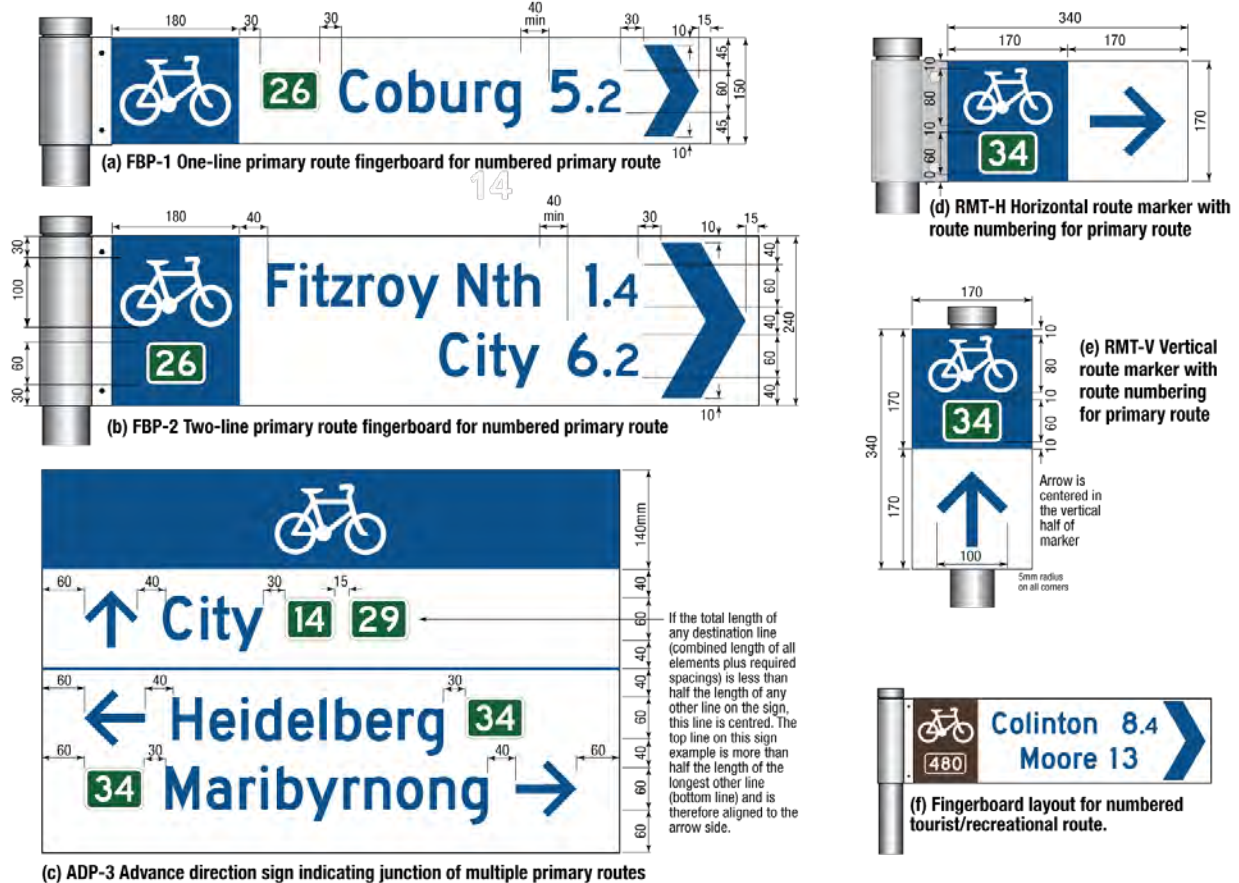

Figure B 18: Numbered route signs on primary and tourist/recreational routes –design layouts



B.4.5 Identify any branded routes

Longer tourist/recreational routes are being developed in many Australian and New Zealand communities. Part of the implementation of these routes, which may often pass through a number of local government areas, is the application of a common branding and promotional identity which often encompasses design elements such as a branding logo, specialist wayfinding and facilities sign designs.

Veloway, primary and tourist/recreational route signs can include route branding indication as follows (see Figure B.19):

- Logos are the preferred method of branding. Logos use a simplified design and are instantly recognisable.
- Cycle route branding can be integrated into sign designs or installed as a separate sign above or below fingerboards. When an external route branding sign is used with a fingerboard for the same route, the branding sign is mounted above the fingerboard. If an external route branding sign is installed with a fingerboard for an overlapping primary or tourist/recreational route, fix the external branding sign below that fingerboard (see Figure B.19b).
- Route numbering always takes precedence over route branding.
- Route branding and route numbering are separate systems with potentially overlapping segments. When branding logos are used on the same destination line as route numbers, the route number indicator is positioned next to the destination name.

Figure B 19: Examples of route branding on direction signs

Route branding logos used in examples on this page. These examples are used for demonstration purposes only and are not intended to depict actual routes

- 

Example: Inner City Ring Route (urban)
A branded ring route approx 2km from city centre. Route uses segments of other radial and cross city routes.
- 

Example: Capital City Route (urban/tourist/recreational)
A branded circuit route approx 5km from city centre. Route number 146. Route uses segments of other radial and cross city routes.
- 

Example: Major Cycle Route Network (urban)
All 13 high-quality routes (the core of the Christchurch primary cycle route network) are branded with MCR logo.
- 

Example: Brisbane Valley Rail Trail (rural/tourist/recreational)
Rural rail trail using a mixture of off-road trails and on-road mixed-traffic connections. Route number 480.

When integrated into the sign face, branding logos are 60x60mm maximum. When used on an external plate (as shown below right) they can be 150x150mm



(a) FBP-1 One-line primary route fingerboard with route branding (and numbering)
Showing two overlapping numbered regional routes overlaid with a branded tourist/recreational route

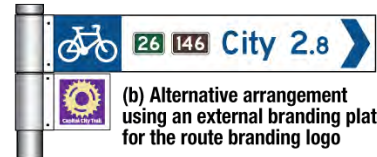

(b) Alternative arrangement using an external branding plate for the route branding logo



(c) FBP-2 Two-line primary route fingerboard showing branded route



(d) FBT-2 Fingerboard layout for numbered and branded route. The route number always takes precedence in the coloured area above the bicycle symbol. In this case the route branding logo is included on the main sign area.



(e) FBT-2 Two-line fingerboard with external branding plate/sign
Branding logo sign is a mini-fingerboard type

Route branding indicators are mounted above fingerboards if the fingerboard shows only destinations for the branded route. For overlapping routes where the branded route is listed on signage with other primary routes, the route branding indicator is mounted below the primary route fingerboard (see diagram (b) above).



(f) RMT-H Horizontal route marker
Double-sided, end mounting



(g) RDP-3 Primary route reassurance direction sign for branded and numbered routes
This example shows a RDP-3 sign for numbered route (12) indicating upcoming destinations with numbered cross routes (88 & 19). Route 19 is also branded as the Inner City Ring Route at this junction.



(h) RMT-V Vertical route marker
With route branding logo integrated into marker design.



(i) RMT-V Vertical route marker with route numbering

B.4.6 Conduct a pre-sign risk assessment

Prior to the installation of directional signs on a cycle route it is recommended that a physical risk assessment of the route is made (see Table B.4 example). This assessment will study the route to determine if it can be legally cycled. The condition of existing cycle facilities on- and off-road, intersections/crossing points and any critical safety issues will be noted. Where major deficiencies occur in the permanent infrastructure (one-way streets preventing two-way cycle access, off-road sections where cycling is not permitted, continuous medians preventing route turns etc) remedial action will be recommended and carried out prior to sign installation.

The type and extent of remedial work will usually depend on the structure of the road environment and the availability of any bicycle specific treatments and infrastructure. Recommendations for pre-sign risk-assessment procedures are provided in the Queensland Transport and Main Roads publication A Guide to Signing Cycle Networks (search title on the TMR website www.tmr.qld.gov.au).

Table B.5: Sample summary of pre-sign risk-assessment issues and recommendations

Route	Route extent	Summary of issues to be resolved before sign installation	Recommended actions prior to sign installation
R4	Gladesville to Randwick / UNSW	Bucknell Street closure not signed as a shared path. O'Dea Avenue (southern side between Joynton Avenue and South Dowling Street not signed as a shared path. Narrow bridge across rail line near Erskineville Station. Wilson Street contra-flow lane median needs a constructed gap to permit turn into Bucknell Street.	Install shared path signs at the Bucknell Street closure, O'Dea Avenue between Bourke Street and Joynton Avenue. Install guidance signs for cyclists to dismount on the narrow pedestrian bridge over the railway on Erskineville Road. Construct turning gap in Wilson Street median at Bucknell Street. Route signed as recommended in signage schedule.
R7	Newtown to Bondi Junction	This route is currently rideable as described.	Route to be signed as recommended in signage schedule.

B.4.7 Design sign layouts for route junctions

Figure B 20, Figure B 21, Figure B 22, and Figure B 23 show recommended intersection sign layouts for the four route types: veloways, primary, local and tourist/recreational routes. Due to the complexity of intersections it may often be advisable to use a graphical layout-type sign for advance direction signs.

Figure B 20: Typical intersection sign layout for veloways

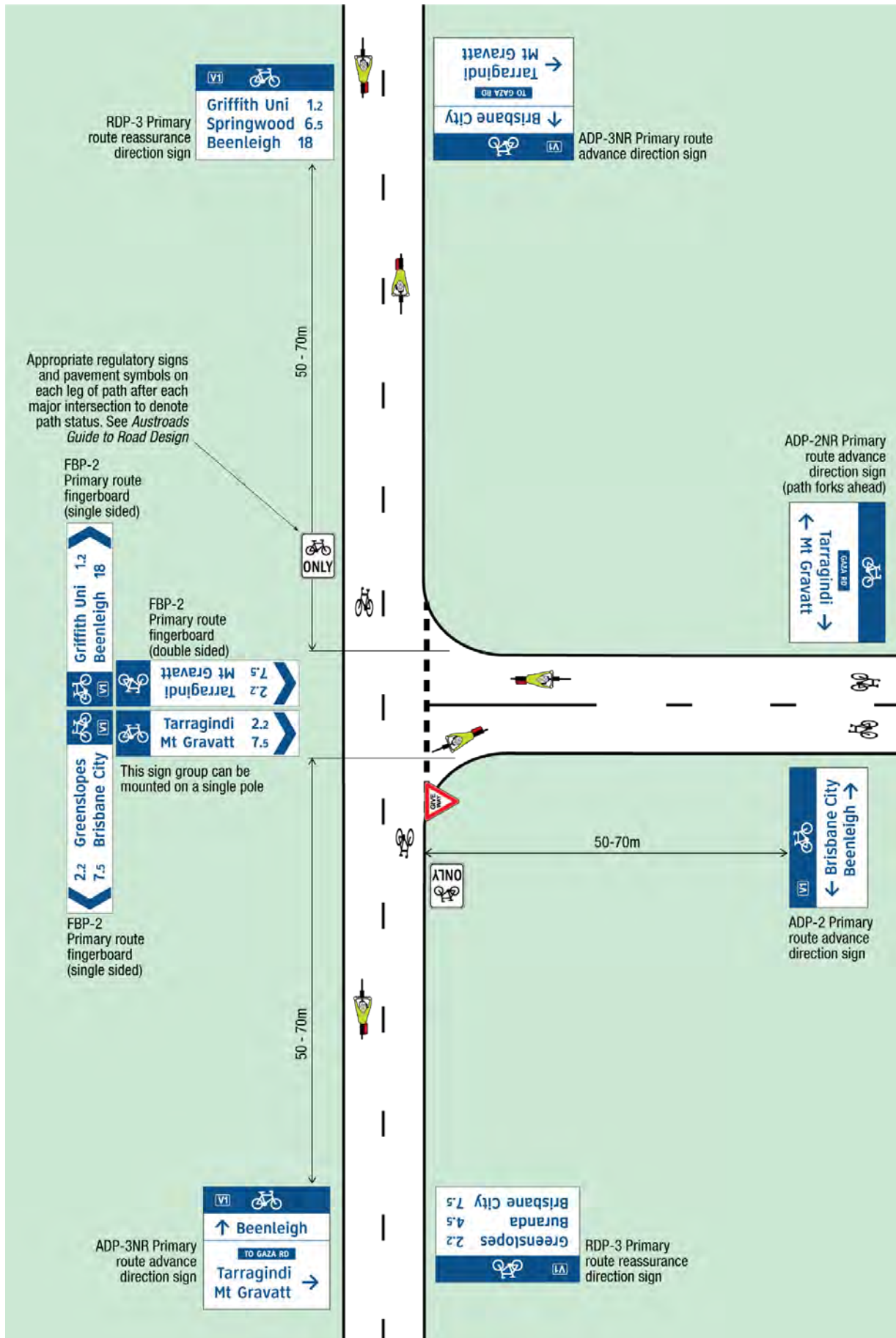

Figure B 21: Typical intersection sign layout for primary cycle routes

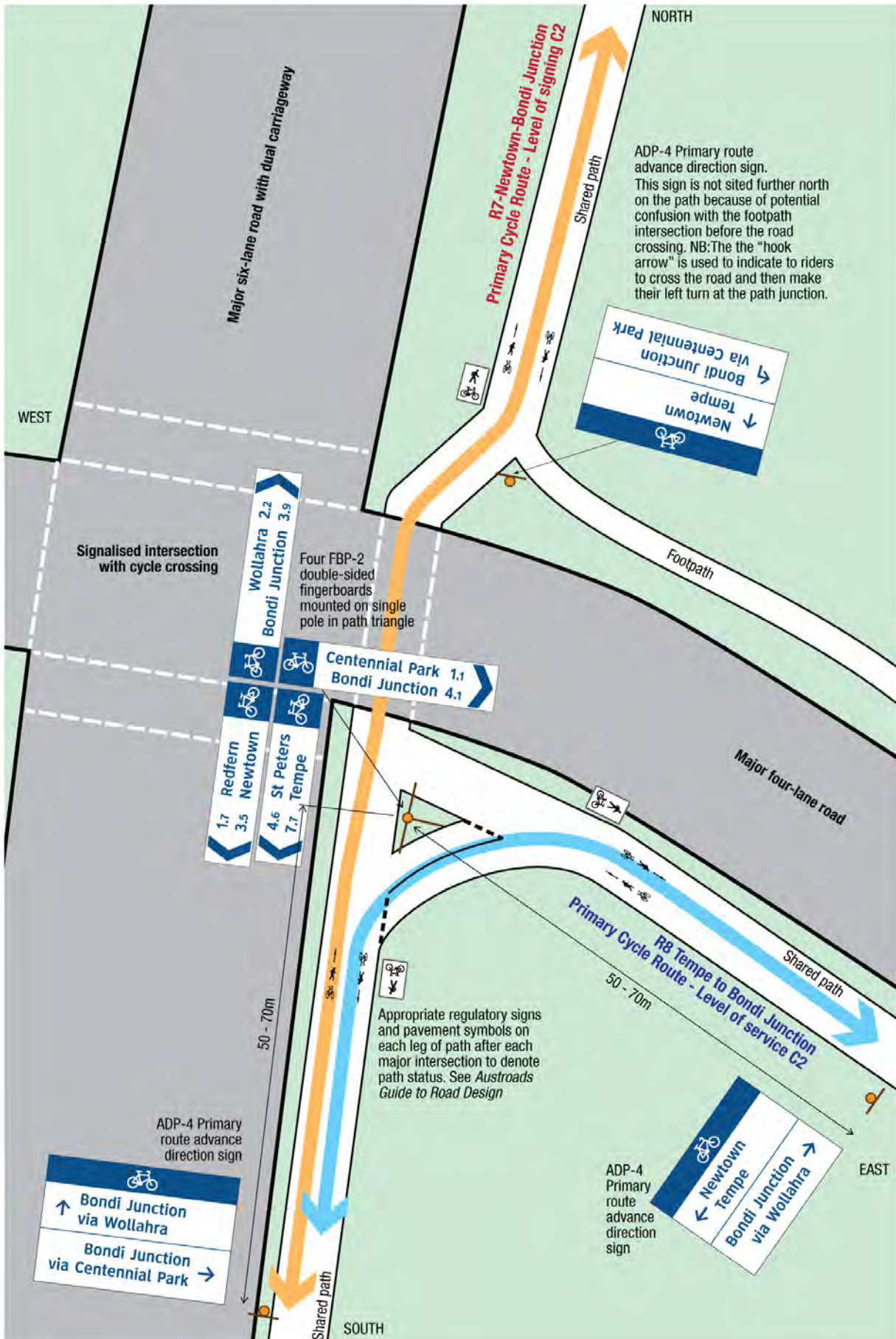

Figure B 22: Typical intersection sign layout for local cycle routes

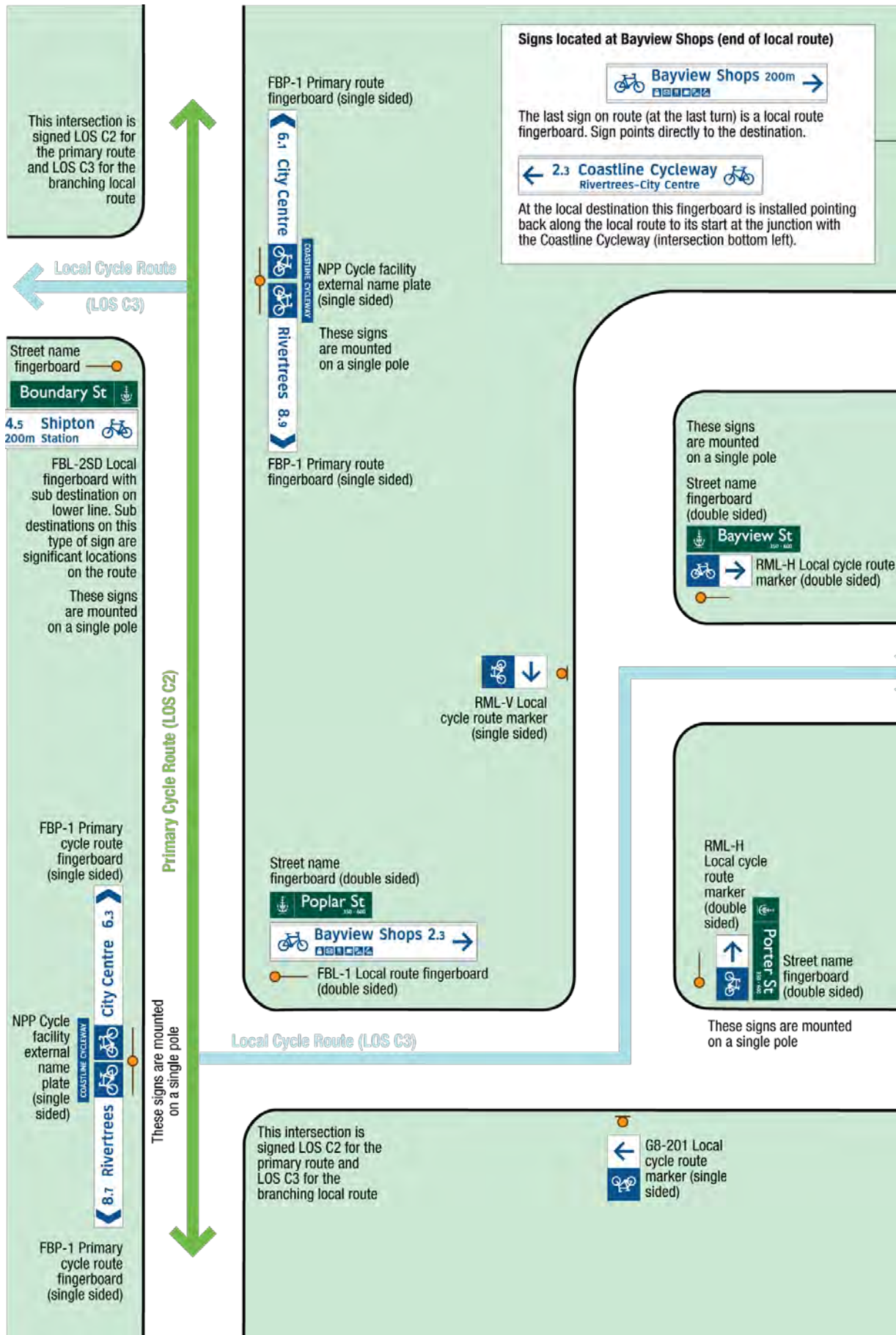
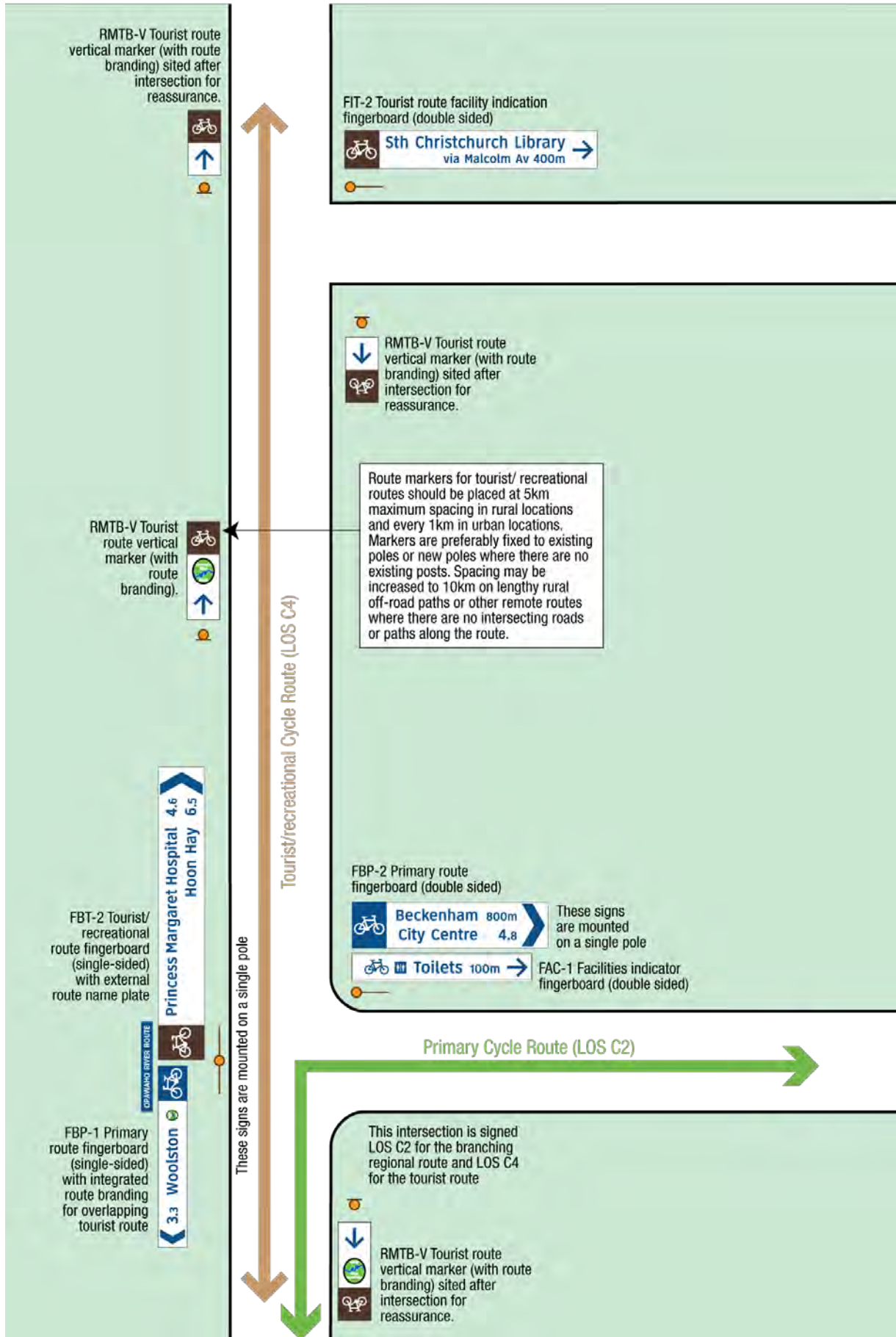

Figure B 23: Typical intersection sign layout for tourist/recreational cycle routes



B.4.8 Create sign schedules

A sign schedule (see Table B.6 example) is the key reference document used to specify the content and location of all signs in the project. Typical details included in a sign schedule are:

- Contents for all signs in the project (including destinations, distances and direction arrows etc). To determine which destinations to show on advance direction signs for intersecting routes, refer to the Focal Point Map which lists all destinations applicable for each route.
- Precise location of each sign. It is recommended that marked-up site photos, detailed site maps or diagrams be appended to the sign schedule to ensure an accurate communication with the sign installer for each sign's particular siting requirements;
- Mounting details/requirements (new pole, existing poles, modifications to existing, fixing type etc);
- New signs found necessary by the site assessment – missing regulatory signs, services and facilities signs, signs indicating connecting paths to the street system, additional signs at junctions for separate on- or off-road facilities and street name signs at junctions and route turnings;
- Redundant signs to be removed; and,
- Additional works required to fully install the signs (minor tree pruning and branch removal where vegetation obscures signs when installed).

Table B.7: Sample signage schedule for part of a cycle route.

Site Ref	Junction description	Sign No	Sign type	Ref No	Travel direction	Sign lettering	Remarks and mounting requirements
1	Southern Motorway Shared Path and Springs Road	1	Fingerboard	FBP-02	E	Middleton 5.8 → City Centre 10	Mounting location to be specified
		2	Fingerboard	FBP-02	W	Prebbleton 2.6 → Lincoln 9.9	Mounting location to be specified
2	Southern Motorway Shared Path and Awatea Road	3	Fingerboard	FBP-02	E	Middleton 3.7 → City Centre 8.2	Mounting location to be specified
		4	Fingerboard	FBP-02	W	Prebbleton 4.7 → Lincoln 12	Mounting location to be specified
		5	Fingerboard	FBL-01	N	To Awatea Road →	Mounted on same pole as above two signs and pointing along path to Awatea Road
		6	Fingerboard	FBL-02	S	Southern Motorway Cycleway → City Centre – Lincoln	At path termination near Awatea Road pointing towards cycleway
3	Southern Motorway Shared Path and Aidanfield Drive	7	Fingerboard	FBP-02	E	Middleton 2.6 → City Centre 7.1	Mounting location to be specified
		8	Fingerboard	FBP-2	W	Prebbleton 5.8 → Lincoln 13	Mounting location to be specified
		9	Fingerboard	FBL-1	N	To Aidanfield Drive →	Mounted on same pole as above two signs and pointing along path to Aidanfield Drive
		10	Fingerboard	FBL-2	S	Southern Motorway Cycleway → City Centre – Lincoln	At path termination near Aidanfield Drive pointing towards cycleway
4	Southern Motorway Shared Path and Hayton Road extension (N side of motorway near underpass)	11	Fingerboard	FBP-2	N	Middleton → City Centre	Mount on existing steel lighting pole with Signs 12 and 13 opposite start of Mortorway Cycleway. Remove all existing directional signage at or near this site.
		12	Fingerboard	FBP-2	W	Prebbleton → Lincoln	Mounting on same pole as Sign 11
		13	Fingerboard	FBL-1	S	To Canterbury Agricultural Pk 1.2 →	Mounting on same pole as Sign 11
5	Southern Motorway Shared Path and path exit/entrance to W end of Wigram at Hayton Road intersection	14	Fingerboard	FBP-2	E	Middleton 1.7 → City Centre 6.3	Mount on new taller pole with Signs 15 and 16. This pole replaces current sign pole containing Wigram Rd and Hayton Rd signs. Remount these signs on new pole below signs 14, 15 and 16. Remove all existing directional signage at this site.
		15	Fingerboard	FBP-2	S	Prebbleton 6.6 → Lincoln 14	Mounting on same pole as Sign 14
		16	Fingerboard	FBL-1	S	To Canterbury Agricultural Pk →	Mounting on same pole as Sign 14
6	Wigram Road E end and start/finish of shared path	17	Fingerboard	FBP-2	E	Middleton 1.1 → City Centre 5.6	Mount on existing pole (in place of existing direction sign board to be removed) at NE side of path/road junction.
		18	Fingerboard	FBP-2	W	Prebbleton 7.3 → Lincoln 15	Mounting on same pole as Sign 17

B.4.9 Prepare sign artwork for manufacture

The completed route sign schedule can now be used to manufacture the signs. The first stage of this process is to transfer the information in the sign schedule into electronic artwork for each sign. This work is usually undertaken 'in-house' by the sign manufacturer or by an external graphic artist.

It is recommended that the sign project designer/planner recheck all electronic sign layouts for accuracy prior to sign fabrication. Sign layouts shall conform to the sign layout templates in Australian Standard *AS1743 Road Signs – Specifications*.

B.5 Signing complex intersections

Often it is not possible to indicate a simple path through a road intersection due to the size and location of the roads through the junction and the complexity of the intersection layout. This is particularly an issue when routes transition between on- and off-road facilities at large multi-laned, signalised intersections. Figure B 24 and Figure B 25 show examples of complex cycle route junctions (both four-way cross routes) with captioned advice on signing cycle routes through these busy intersections.

B.5.1 Intersection Signing Example 1

Figure B 24 shows a sign example for an off-road cycleway travelling through a complex intersection. Some signs are not shown in this photomontage but mentioned in this commentary. Cyclist path is shown in red.

The signs are listed below:

1. Due to the complexity of the intersection it is advisable to use a graphical layout type advance direction sign to indicate the optimal route through the intersection.
2. At this off-road path junction three fingerboards (on the same pole) indicate route turnings.
3. In advance of this intersection, a graphical layout-type advance direction sign, similar to 1, faces cyclists travelling from the opposite direction.
4. At this route junction three fingerboards (on the traffic island) indicate the route turnings.
5. In advance of this intersection, a graphical layout-type advance direction board, similar to 1, faces cyclists travelling from Griffith University.
6. A graphical layout-type advance direction sign, similar to 1, also faces cyclists approaching the intersection from Upper Mt Gravatt.

Figure B 24: Sign example for off-road cycleway travelling through a complex intersection

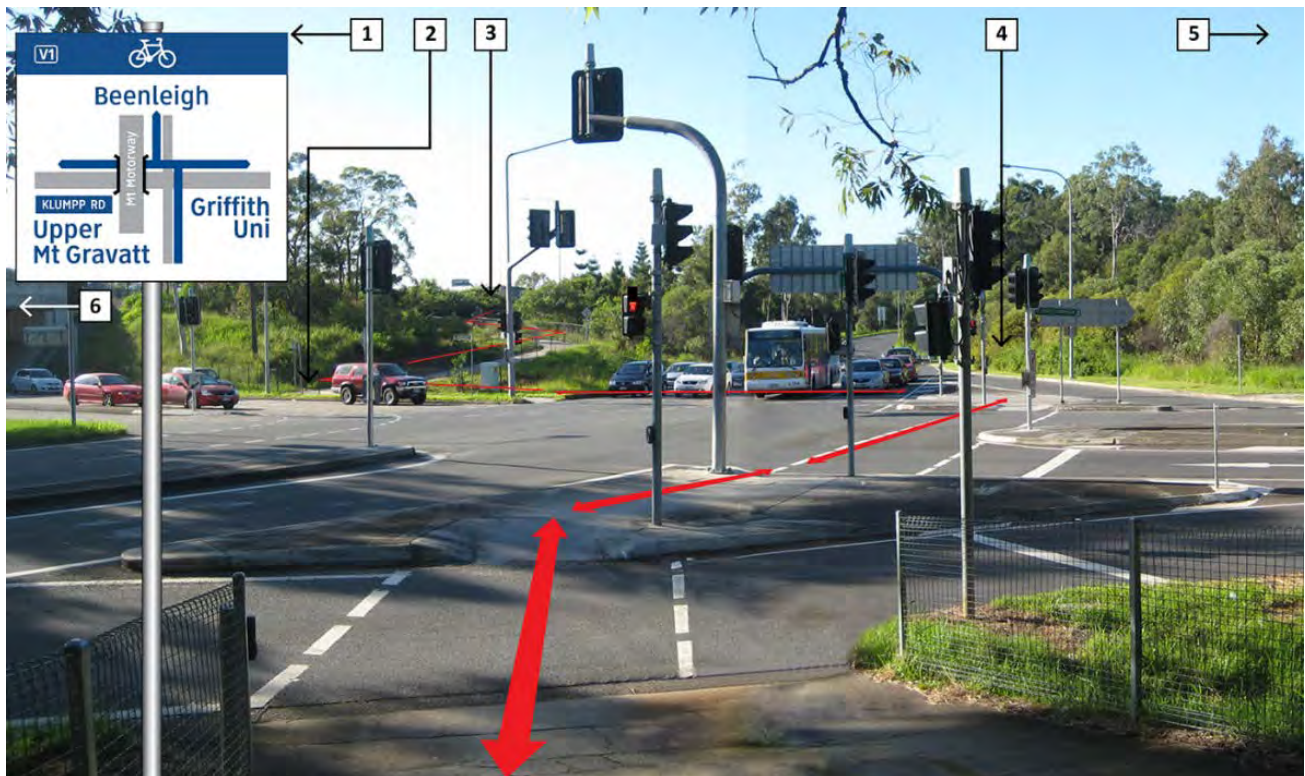

B.5.2 Intersection Signing Example 2

Figure B 25 shows a sign example for an off-road cycleway travelling through a large complex intersection. Some signs are not shown in this photomontage but mentioned in this commentary. The triangular traffic island marks the crossing point of three routes. The signs are listed below:

1. Two routes enter the intersection from the south (left of frame). These routes share the same path. Advance direction and reassurance signs are erected beside this path 30-50 metres south of this intersection.
2. These routes cross the slip lanes to the traffic island where they diverge. An east-west route also crosses at this point. (A) This cyclist has ridden across the bus road and is crossing the slip lanes to the traffic island following an east-west route from Bondi Junction. (B) On the island a cyclist waits for a crossing signal before continuing westwards.
3. On the western side of the intersection is another triangular traffic island with slip lane adjacent.
4. At the junction of the routes a sign pole has been erected. At this important path junction six fingerboards on the pole indicate the travel direction for each of the three routes. Intersection signing can be greatly simplified if, as in this example, the fingerboards can be sited on one pole so that they can be clearly seen from all approaches. Due to the complexity of some intersections this is not always possible. Each intersection needs to be individually assessed and signs erected for maximum wayfinding clarity. (C) This cyclist waits for the signal before resuming travel towards the City on the north-south route.
5. The complexity created by the additional crossing of this north-south busway will require a reassurance direction sign to be located closer to the intersection to provide visual guidance for cyclists travelling towards Bondi Junction.
6. Multi-staged road crossings (due to slip lanes) require careful assessment to ensure that a clear route direction is indicated by all signs.
7. Advance direction and reassurance signs are erected beside this path 30-50 metres north of this intersection.

Figure B 25: Sign example for an off-road cycleway travelling through a large complex intersection

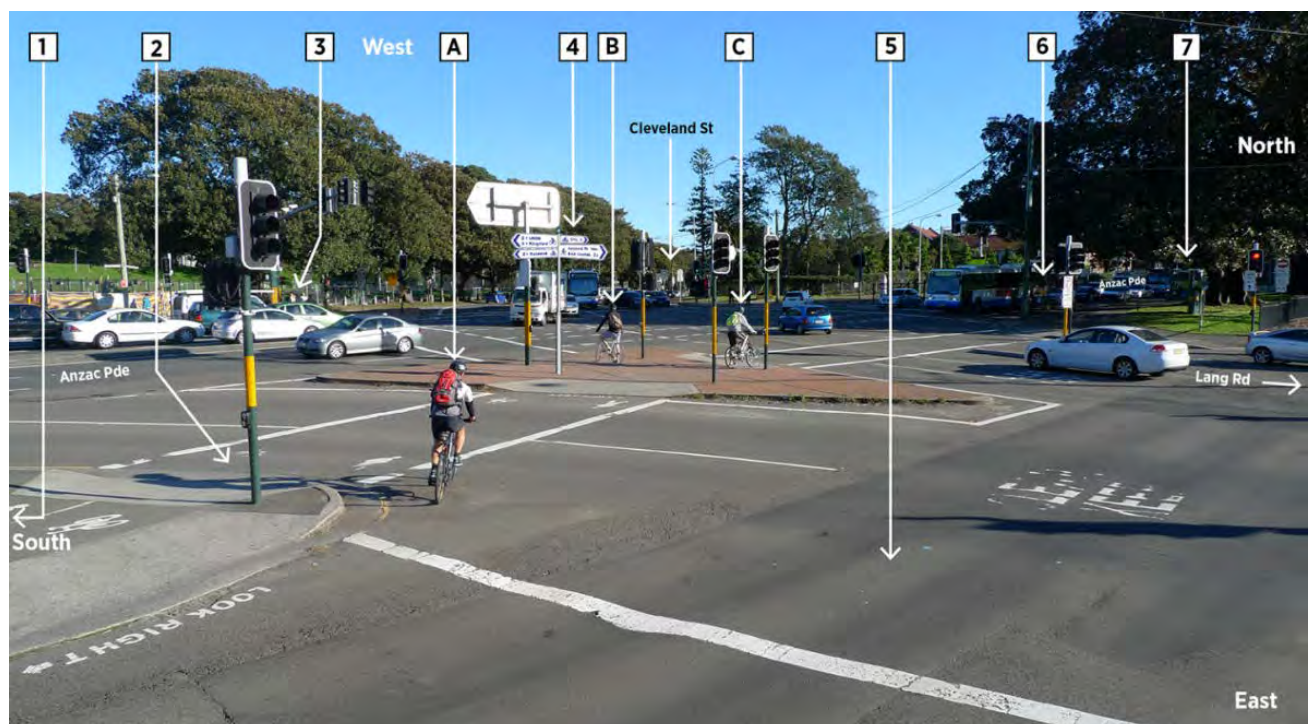

B.6 Sign installation

The manufactured signs can be installed according to the sign schedules and detailed siting instructions provided by the sign system planner/designer. Additional advice and recommendations on sign installation issues are provided below.

B.6.1 Sign mounting and clearances

Signs are mounted in full view of cyclists using the cycle route, and located so that they provide clear unambiguous directions at critical turning points or junctions. Take care to place signs where they can be clearly seen by cyclists and in a location where their message is not compromised or overwhelmed by proximity to other road signs or structures.

Site cycle network signs so that they do not diminish the effectiveness of, or conflict with, existing road signs and create ambiguity for other road users.

Cycle network signs, like highway signs, are a discrete system designed to guide cyclists through often complex road environments. Cycle route signs are not included with, or mounted on, main/arterial road directional signs or sign supports. Cycle route directional messages are not included or integrated into main/arterial road signs.

Minimise sign clutter by utilising existing sign poles and street poles where this does not compromise the effectiveness of the direction sign or the host sign. Mounting on existing power poles is permissible provided that the council or road agency has an arrangement with the power utility to sanction this. In urban environments some councils permit the co-use of parking sign poles as a clutter reduction measure.

Mount signs at a clearance height of 2.5m and preferably no higher than 4.0m (see Figure B 26). Sign supports need a minimum of 0.5m clearance from the cycleway or roadway. Do not mount signs so that they overhang the roadway or interfere with turning vehicles.

Figure B 26: Sign clearance details

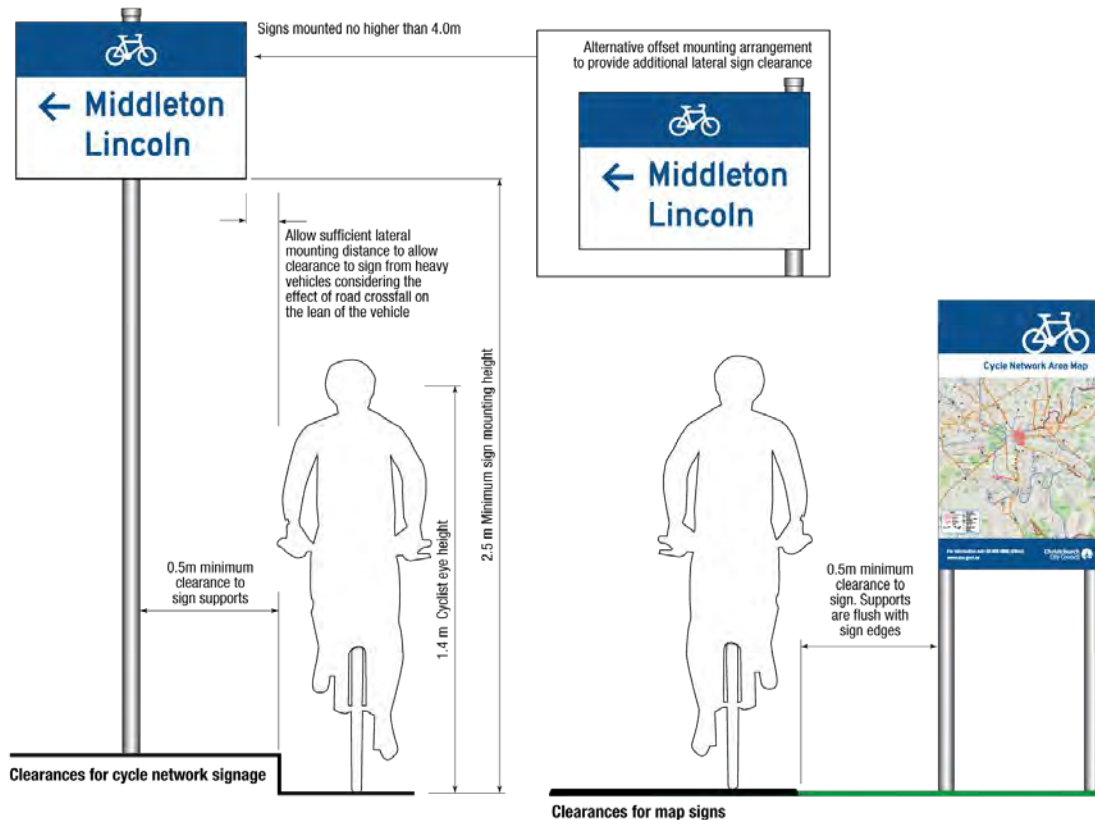

Where there is a risk that signs could be rotated by either wind or vandalism, use anti-rotational fittings or fixing screws. This is particularly important on fingerboard signs which indicate travel direction at intersections.

Mount map and information display signs with sufficient horizontal clearance (1.5m minimum, 2.0m preferred) to permit cyclists and other path users to comfortably view the sign and still provide clearance to other street/path users.

Route markers for tourist/recreational routes on rural routes are placed at 5km maximum spacing and generally located on existing sign posts or new route marker posts where there are no existing sign posts. Spacing may be increased to 10km along off-road paths or other remote routes where there are limited or no intersecting roads/paths along the route. In urban environments, place markers on continuous or branded recreational routes at 1km intervals increasing to 2km where there are no intermediate junctions.

B.6.2 Sight distances and sign visibility

At cycle route junctions/decision points, position directional signs so that cyclists can safely read the signs and comfortably follow their chosen route. Stopping distance and the sight distance to the intersection are also important in hilly conditions.

When placing advance direction signs it is essential to take into account all local variables such as slope and sight distances. Locate signs to provide adequate warning of a change of direction depending on the site. Table B.8 lists recommended mounting distances for advance direction signs. Allow a greater distance where there is a downhill grade towards the intersection or where the approach visibility is restricted. For grades steeper than 8% additional warning signs are recommended in advance of the intersection.

Mount intersection fingerboards in a highly visible location so that they can be clearly read by cyclists at a minimum of 15m from the intersection.

Table B.9: Advance direction sign mounting before intersections

Route type	Design speed	Recommended mounting distance from intersection
Veloway	Above 30km/h	50-70m
Primary	30km/h	35-50m
Local	Below 30km/h	30m
Tourist / recreational	Below 25km/h	30m

Place signs consistently as indicated in Figure B.19 to Figure B.22. If two signs indicating separate directions cannot be mounted on the same pole on one corner of an intersection due to site conditions, consider separately mounting these signs. Consider also mounting signs on existing sign poles or power poles (where an agreement exists between the road/street/path owning authority and the power supply company) provided that such mounting offers superior sight lines and visibility for the sign(s).

B.6.3 Sign legibility and lighting

Direction signs need to be easily readable in either day or night conditions. Signs located in a normal urban environment usually have adequate ambient lighting. If possible, locate signs under, or adjacent to, overhead lighting.

B.6.4 Sign stack mounting order

At major junctions it is important to place fingerboards in a logical vertical order so that cyclists can easily follow the signs for a particular route. Generally, fingerboard pairs for a continuous route through a junction are placed together in the vertical sign stack (see Figure B.27). Ideally fingerboard pairs for the same route are mounted at the same level but this may not be possible due to mounting system limitations. Always consider sign visibility from different approaches for large sign installations when multiple routes pass through junctions.

Figure B.27: Sign stack order details

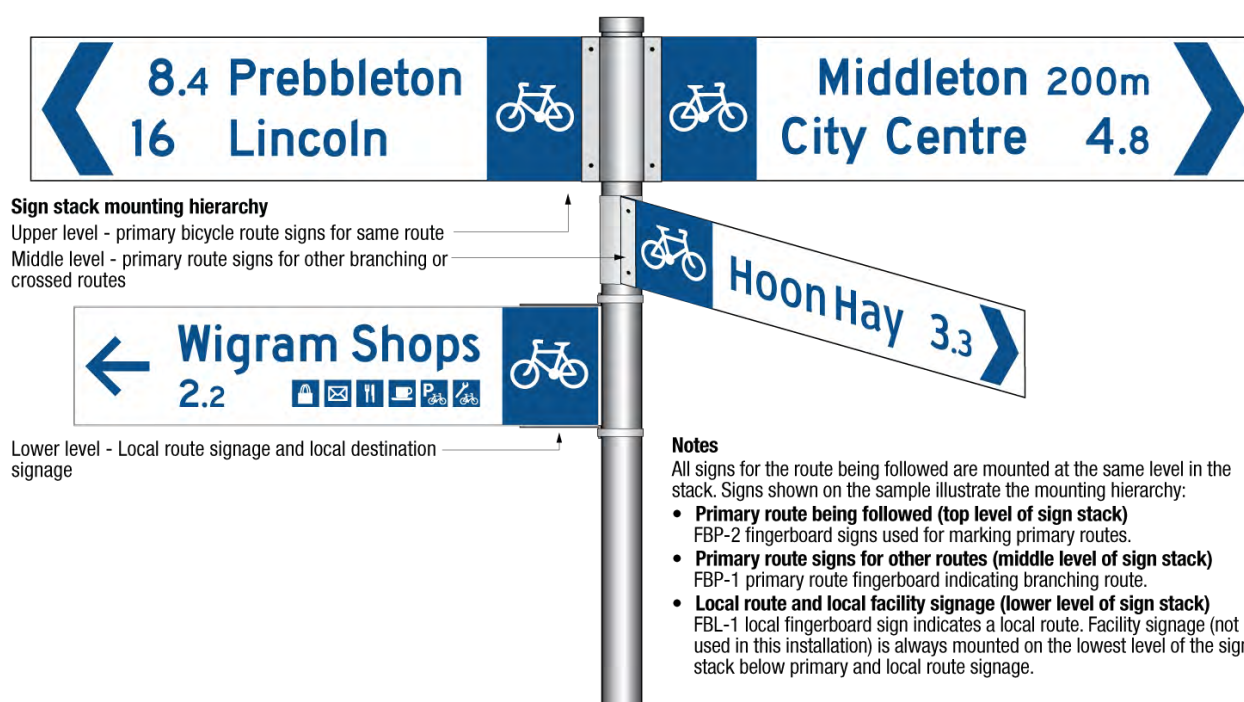

B.6.5 Integration with existing path signs

Many local governments are implementing wayfinding sign systems to assist people using shared paths and urban greenways. Many of these paths have been developed with unique signs and branding. Cycle network signs installed as an overlay on existing paths (with existing signs) require careful sign placement to ensure the needs of path users and the cycle network are fully accommodated.

Cycle network signs should be kept to a minimum of locations as follows:

- Entry to path where the primary route joins;
- Path branching intersections of other primary and local routes; and,
- Exit from path of the primary route.

Existing path signs should provide the necessary destinations, distances, directions to facilities, cross street/access path naming and map signs. Off-road paths and path junctions are signed the same as on-road routes. Where no existing path sign system is in place, normal cycle network signs are applied throughout the path.

B.6.6 Post-installation check and review

Following installation, the location and sign contents are finally checked on site by the sign system planner/designer. All signs need to point in the right direction and be easily visible to cyclists riding the route. Signs wrongly installed or containing inaccurate information will be documented and supplied to the sign installer for rectification.

B.7 Sign maintenance

Cycle network direction signs can be installed during the implementation phase of a cycleway project or retrofitted as part of a longer term program for high quality wayfinding and directional sign systems across a cycle network.

The maintenance of cycle route direction signs is usually the responsibility of the government agency, local government or private landowner that owns or operates the road, street or path. It is important that ongoing sign maintenance responsibilities be assigned and carried out, particularly where joint funding and partnership arrangements have installed the signs and infrastructure. Any ongoing maintenance of cycle network infrastructure needs to include the maintenance of the sign system.

B.7.1 Sign defect reporting systems.

Cycle route directional signs are like links in a chain. If a single sign is removed the chain is broken and cyclists can lose their way resulting in a reduction of confidence in the system. Asset managers/owners are increasingly interested in accurate reporting systems which allow them to more efficiently maintain infrastructure such as cycling network directional signs.

Internet-based infrastructure defect reporting systems are currently used by a number of ANZ councils and government agencies. It is important that these defect reporting systems be accessible to the cyclists who regularly use the network to ensure prompt reporting of missing or damaged signs. This type of reporting system is recommended as it encourages network users to report faults which may otherwise take much longer to detect under the asset authority's regular maintenance inspections.

It is essential that asset items relating to cycling signs be added to existing internet-based defect reporting systems as soon as directional signs are installed so that users may make an accurate selection from the reportable faults listed on the system.

B.8 Alternative Sign Design Options

B.8.1 Time Markings

Where travel times are desired in addition to distances, they should be calculated at a speed of 15 km/h and rounded to the nearest minute. Due to the wide range of travel speeds between cyclists of different abilities, it is recommended that travel times greater than 30 minutes are not shown on signs.

Figure B 28: Sign designs including time indications

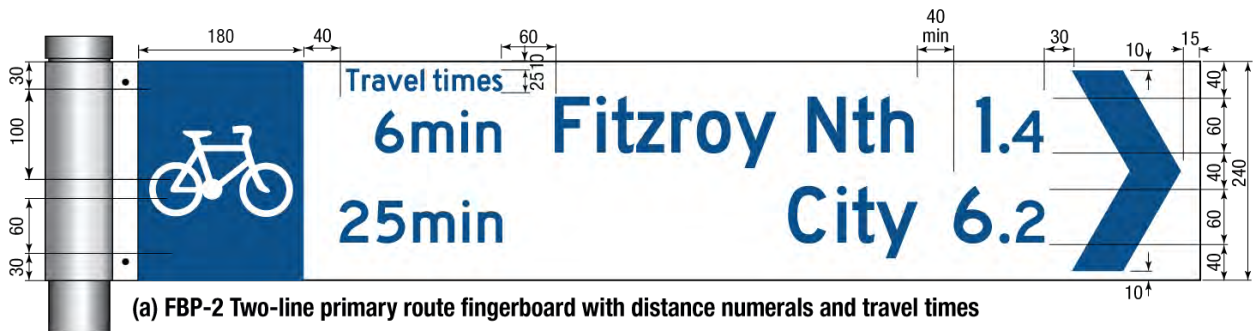

B.8.2 Shared Route Markings

Wayfinding signs that indicate that the route is for both pedestrians and cyclists are only to be used on active transport networks in jurisdictions where cycling is legally permitted off-road within the road corridor. These signs are only to be used on routes designed for both pedestrians and cyclists for their full length.

Primary and local bicycle routes are always signed using the bicycle symbol only (to differentiate the sign system from other road signage for general use). The signs shown in Figure B 29 are advisory directional signs only and should not be used in place of normal shared path regulatory signs.

Figure B 29: Sign designs including both a pedestrian and a bicycle symbol



(a) FBP-1 One-line primary route fingerboard artwork template



(b) FBP-2 Two-line primary route fingerboard artwork template



(c) FBL-2PR Local cycle route fingerboard indicating a junction with a primary route
The end destinations of the primary route are shown on the lower line.



(d) DIP-2 Two-line direction indication sign artwork template

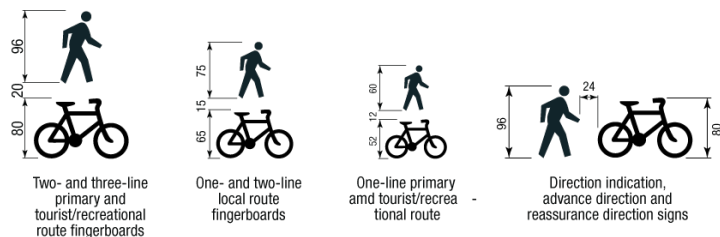

(e) User symbols template for route shared between pedestrians and cyclists

Appendix C Recommendations for AS1743 – Road signs - Specifications

C.1 Scope

This appendix sets out the layouts and dimensioning for cycle network directional signs as described in AS1742.9: 2015 Section 5.

C.2 Basic sign design elements

Cycling network directional signs consist of a white retro-reflective background (Class 2 super engineering grade retro-reflective material) with AS2700 B23 Bright Blue colour lettering.

All cycling directional signs include a large white bicycle symbol (as per AS1742.9 2015) against an AS2700 B23 Bright Blue background. This symbol is displayed on fingerboards at the mounting end and to the top of all other signs (see individual sign design/layout diagrams in this appendix).

Tourism/recreational route signs and markers use AS2700 X65 Dark Brown as a background colour for the bicycle symbol in place of Bright Blue.

The typeface used on all cycle network direction signs is AS1744:2015 Series D (see Figure C.1). On signs with lengthy names where the recommended maximum length of fingerboards may be exceeded, AS1744:2015 Series C typeface may be used.

Figure C.1: Typefaces used on cycle directional signs - design layouts

All measurements for lettering heights on signs refer to the height of the capital letter 'X' referred to in text and in all diagrams as the 'Cap X height'.



Display of destinations and distances on directional signage

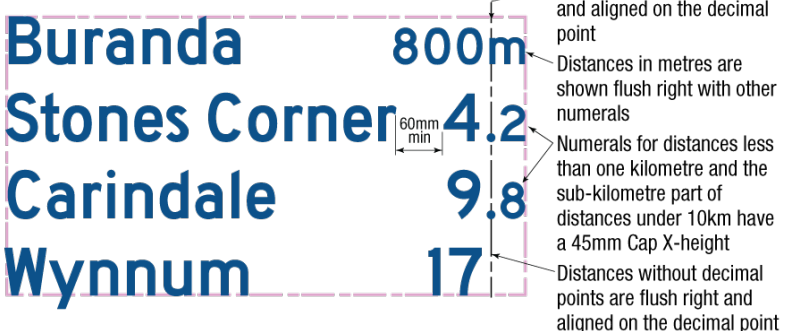

Notes for layout of destination names and distances for fingerboards and reassurance direction signs

1. Destinations are listed flush left. Lettering Cap X-height is 60mm on all signs with the exception of local route signs (sub destinations) and facility name signs and name boxes integrated into signs.
2. Distance numerals one kilometre and above are the same point size as destination names. Numerals for distances less than one kilometre are shown in metres and have a Cap X-height of 45mm.
3. Distance numerals are aligned on the decimal point and to the right side of the sign.
4. Distances less than 10km are shown to the nearest 100 metres in standard decimal form.
5. Distances less than one kilometre are shown in metres (rounded up to the nearest 100 metres e.g.: 500m - see example at left). The numerals and the 'm' abbreviation (no space in between) are aligned right with other destination numerals.
6. If a destination can be seen from the sign location (i.e. less than 100m etc), then a distance is not shown.

All sign lettering is shown as mixed capitals and lower case as detailed in the individual sign layouts. Destination lettering and whole kilometre numerals are 60mm high (Cap X-height) unless specified otherwise in individual sign layouts/templates. Destinations are listed on signs with the destination closest to the sign at the top of the sign and other destinations below in increasing distance order.

Distances to destinations when used are displayed as follows:

- Distances to destinations are shown in kilometres.
- Distance numerals are located between the direction arrow and the destination name.
- Distances above 10km are rounded to the nearest kilometre.
- Distances less than 10km and greater than 1km are shown to the nearest 100 metres in standard decimal form to one decimal place.
- Distances less than one kilometre are shown in metres (rounded to the nearest 100 metres e.g.: 300m). When listed on signs the numerals and the 'm' abbreviation (no space in between) are aligned right with other destination numerals.
- Distance numerals one kilometre and above are the same point size as destination names. Numerals for distances less than one kilometre are shown in metres and are 75% of the height of the whole kilometre numerals (usually 45mm Cap X-height) unless specified otherwise in individual sign layouts/templates.
- Distance numerals are aligned on the decimal point.

Direction arrows used on fingerboard type signs and all other direction signs shall be in accordance with the diagrams/templates shown in Figure C.2. The size and type of direction arrows used on signs is specified on individual sign layout diagrams/templates.

Figure C.2: Arrows used on cycle directional signs – design layouts

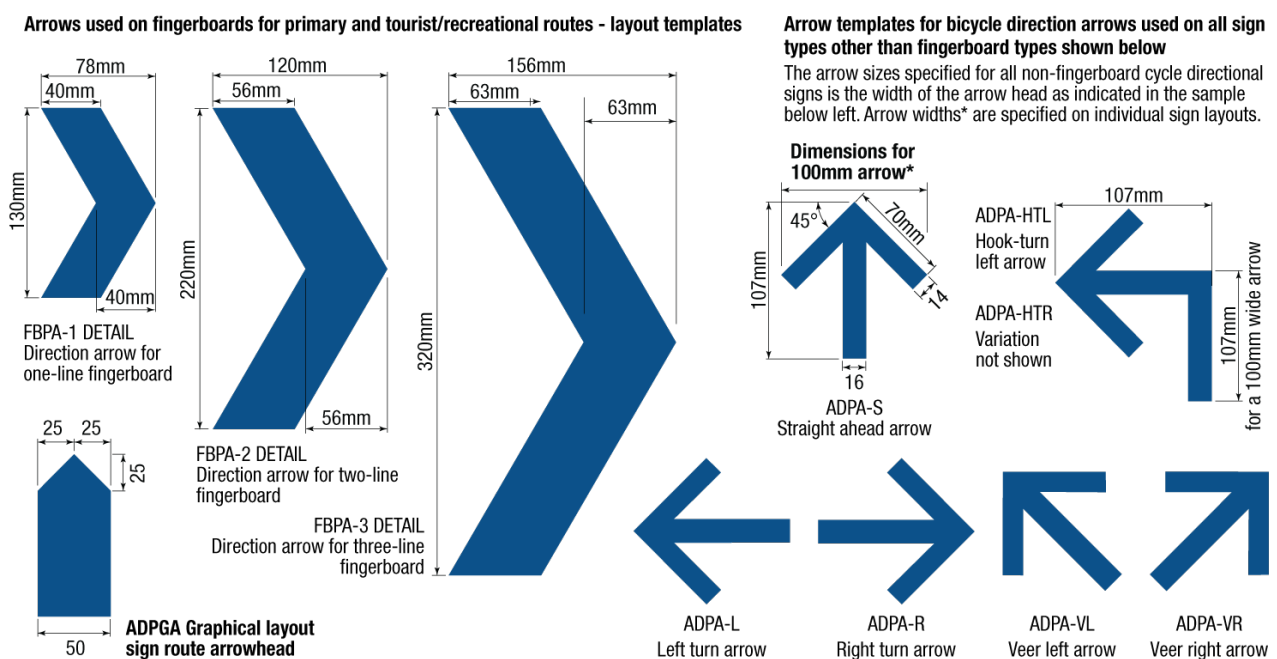

C.3 Veloway and primary route signs

The veloway and primary route sign family consists of a full range of sign types for use on cycle routes which perform the most important transport functions in the network. Though most urban cycle networks use a two-level hierarchy of primary and local routes, in some cities higher-grade routes are being developed. These are usually high-speed limited-access routes such as urban 'veloways' or 'cycling super highways'. In recognition of the higher operating speeds this type of route is signed with the highest level of signing with reassurance direction signs used at route junctions in addition to fingerboards and advance direction signs. Design variations for each sign type within the veloway and primary route sign family are shown in Figure C.3 to Figure C.9.

C.3.1 Fingerboard signs – design details

Fingerboards (see Figure C.3 for layout templates) are designed to include the following design and sign content requirements:

- Fingerboards are double-sided signs constructed from 6mm aluminium sheet with lengths to suit longest combination of sign content elements as per Figure C.3. Fingerboard maximum length is 1200mm.
- A white bicycle symbol (157x100mm) on a blue background is located at the mounting end of each sign face. On fingerboards the bicycle symbol always faces in the direction of travel on both sides of the sign.
- The maximum height of a fingerboard is three lines of text. The usual maximum for fingerboards is two lines of text – a sub destination and a focal point. On routes which need to indicate an additional focal point off the route but with a strong user demand (e.g. City Centres) it is permissible to show two focal points and a sub destination. Three line fingerboards are usually very large signs with high wind loading issues and, if used, must be kept as compact as possible to reduce wind loading. This can be done through abbreviating text or using the AS1744:2015 Series C typeface.
- Distances and destinations are shown as per Section C2.1 of this appendix and located between the destination name and the direction arrow.
- A direction arrow as per Figure C.2 is located on the fingerboard at the opposite end to the sign mounting, pointing towards the direction of travel.
- Destination names are aligned to the distance numerals or to the direction arrow if distances are not used.

Figure C.3: Velway and primary route fingerboards – design layouts

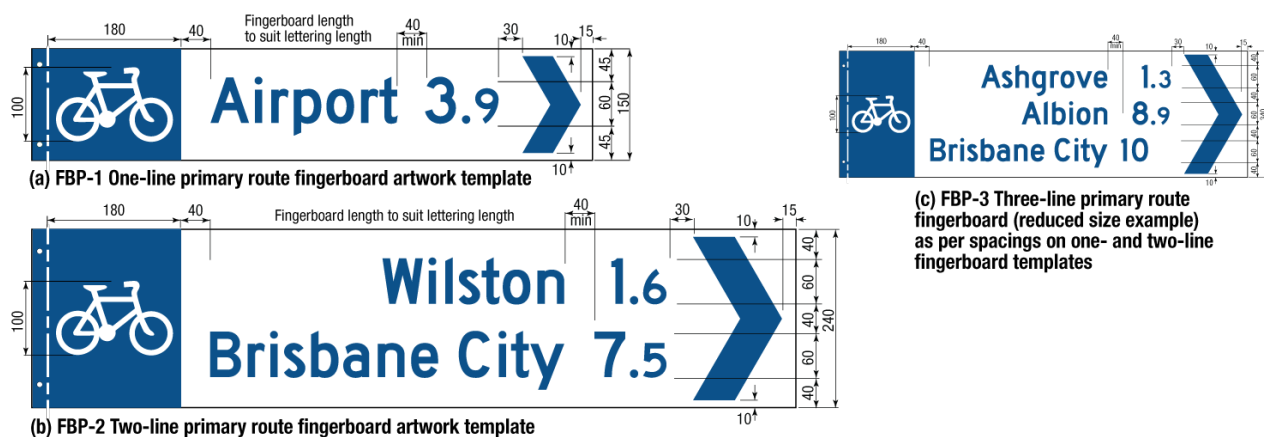

C.3.2 Direction indication signs – design details

Direction indication signs (see Figure C.4) are designed to include the following design and sign content requirements:

- Direction indication signs are single-sided and fabricated from 1.6mm aluminium sheet with channel stiffeners and 5mm radii on all protruding corners.
- Sign widths are to suit the longest combination of sign content elements as per Figure C.4.
- Destination names are aligned to the distance numerals or to the direction arrow if distances are not used.

- A single direction arrow 80mm wide as per Figure C.2 is located on the sign always pointing outwards to the edge of the sign and in the direction of travel. Straight ahead arrows and left turn arrows are located on the left side of the sign with associated destination names left justified towards the arrow. Right turn arrows are located on the right side of the sign with the associated destination names right justified towards the arrow. Where there are two or more destinations sharing the one direction arrow, the arrow is centred vertically on the destinations.
- Distances and destinations when shown are as per Section C2.1 of this appendix and located between the destination name and the direction arrow.
- A white bicycle symbol (157x100mm) is centred in the blue sign header area. The bicycle symbol always faces in the direction of travel if a turn is indicated. Where the sign indicates a straight ahead travel direction, the bicycle faces to the right side of the sign.

Figure C.4: Veloway and primary route direction indication signs – design layouts

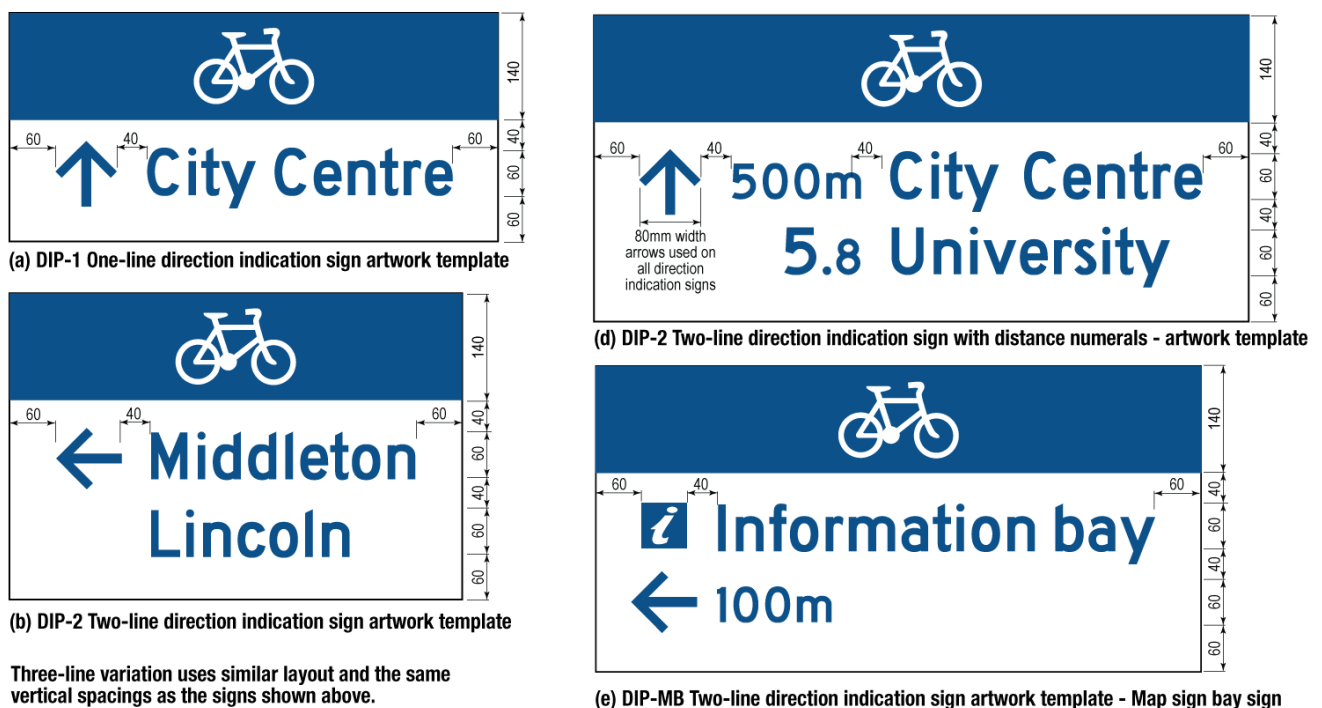

C.3.3 Advance direction signs – design details

Advance direction signs (see Figure C.5) are designed to include the following design and sign content requirements:

- Advance direction signs are single-sided and fabricated from 1.6mm aluminium sheet with channel stiffeners and 5mm radii on all protruding corners.
- Sign widths are to suit the longest combination of sign content elements as per Figure C.5.
- Direction arrows are 80mm wide as per Figure C.2. Arrows always point outwards from the sign towards the direction of travel. Straight ahead arrows and left turn arrows are located on the left side of the sign with associated destination names left justified towards the arrow. Where there are two or more destinations sharing the one direction arrow, the arrow is centred vertically on the destination names.
- The destination name and direction arrow for the route being followed is always shown at the top of the sign. The destinations for other routes crossing or branching at the junction are listed below in order of network importance (routes to more popular destinations are listed ahead of more remote destinations).
- Destinations for branching or crossed routes are grouped with each direction arrow.

- Separate routes are indicated by a horizontal line between the destination(s) for the route being followed and other route destinations.
- A white bicycle symbol (157x100mm) is centred in the blue sign header area. The bicycle symbol always faces to the right side of the sign.

Figure C.5: Veloway and primary route advance direction signs – design layouts

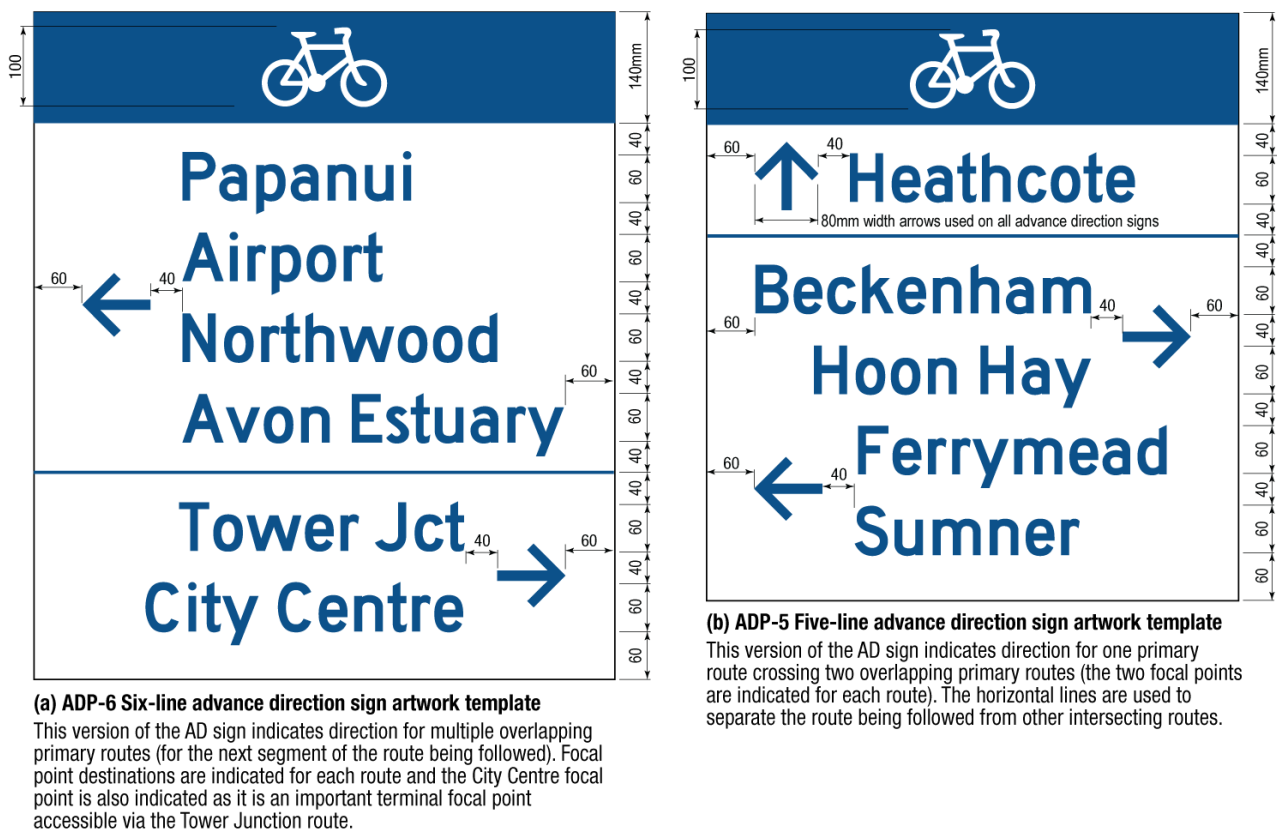

C.3.4 Advance direction graphical layout signs – design details

Advance direction graphical layout signs (see Figure C.6) are designed to include the following design and sign content requirements in addition to the usual advance direction sign layout:

- This sign is individually designed to clearly represent the approximate shape of the intersection including street junction alignments to further assist with navigation.
- The suggested travel paths for all indicated routes is shown by a 50mm wide blue line. See Figure C.2 for advance direction graphical layout arrow head details.
- Relevant streets/roads are shown in 50% grey tone, 80mm wide line for major roads and 65mm wide for minor roads. The names of cross streets are shown in white 30mm high lettering within a 60mm blue box aligned to the street. For clarity and simplified design, secondary street names (roads not used by cycle routes) may be shown in white on the grey lines representing the roads.
- Sign width is determined using standard advance direction sign spacings. Graphical elements should be carefully spaced to ensure good legibility.
- If destination names consist of two words, these can be stacked (with a 25mm vertical spacing) for more compact layout. Where two separate destinations are listed, the normal vertical spacing of 40mm should be used.

Figure C.6: Veloway and primary route advance direction graphical layout signs – design layouts

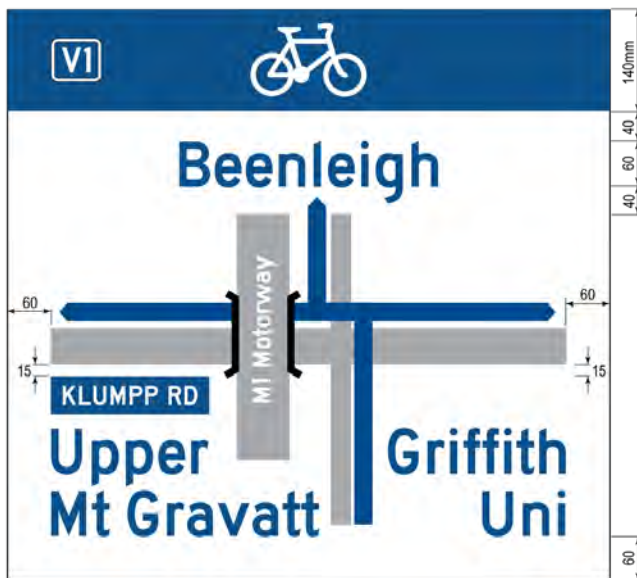

(a) ADPG Graphical layout advance direction sign
For use at complex junctions.

C.3.5 Reassurance direction signs – design details

Reassurance direction signs (see Figure C.7) are designed to include the following design and sign content requirements:

- Reassurance direction signs are single-sided and fabricated from 1.6mm aluminium sheet with channel stiffeners and 5mm radii on all protruding corners.
- Destinations and their distances are listed in ascending order by distance with the closest destination to the sign site shown at the top of the list.
- Destination text and distance numerals are shown as per Section C2.1 of this appendix.
- Sign widths are to suit the longest combination of sign content elements as per Figure C.7.
- A white bicycle symbol (157x100mm) is centred in the blue sign header area. The bicycle symbol always faces to the right side of the sign.

Figure C.7: Veloway and primary route reassurance direction signs – design layouts



C.3.6 Location signs – design details

Location signs (see Figure C.8) are designed to include the following design and sign content requirements:

- Location signs are single sided and fabricated from 1.6mm aluminium sheet or thicker, depending on the mounting requirement.
- The optimal siting for a location sign is on the face of a bridge/overpass structure easily seen from, and directly above, the path. Signs are permanently affixed to the bridge/overpass structure. The method of fixing considers the type, age and materials used in the structure.

Figure C.8: Veloway and primary route location signs - design layouts

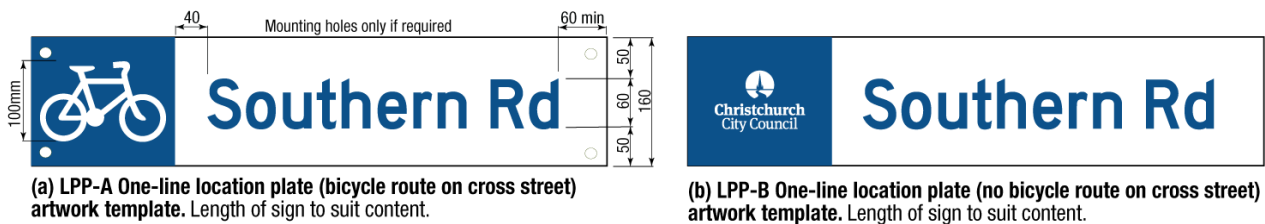

C.3.7 Map signs – design details

Map signs (see Figure C.9a) are designed to include the following design and sign content requirements:

- Map signs are single sided and are fabricated from 1.6mm aluminium sheet with channel stiffeners and 5mm radii on all protruding corners. Signs are mounted flush with their support posts and finished so that they do not protrude into the operational space of the adjacent pathway.
- These signs are sized so that any readable information (text or maps etc.) is a minimum of 700mm from the ground and a maximum height as shown in Figure C.9a.
- Maps signs can also contain additional interpretive information to provide useful wayfinding and tourist information to the user. Figure C.9b shows an example of this type of map sign variation.
- Map signs for on-road routes are sited in an off-road map viewing bay (see Figure C.9c) or in parklands adjacent to the street or road being followed. Map signs ideally are located to allow path users to view the map when facing in a northerly direction to facilitate easy map orientation (if a north-oriented base map is used). Map viewing bays are not recommended on roads with a speed limit greater than 60km/h.
- When siting map signs adjacent to paths and off-road bikeways where no viewing bay is provided, map signs are located at least one metre from the path edge to ensure there is sufficient space to move off the path to read the sign and not create a hazard for other path users.

Figure C.9: Veloway and primary route map signs and map sign viewing bay adjacent to a road – design layouts

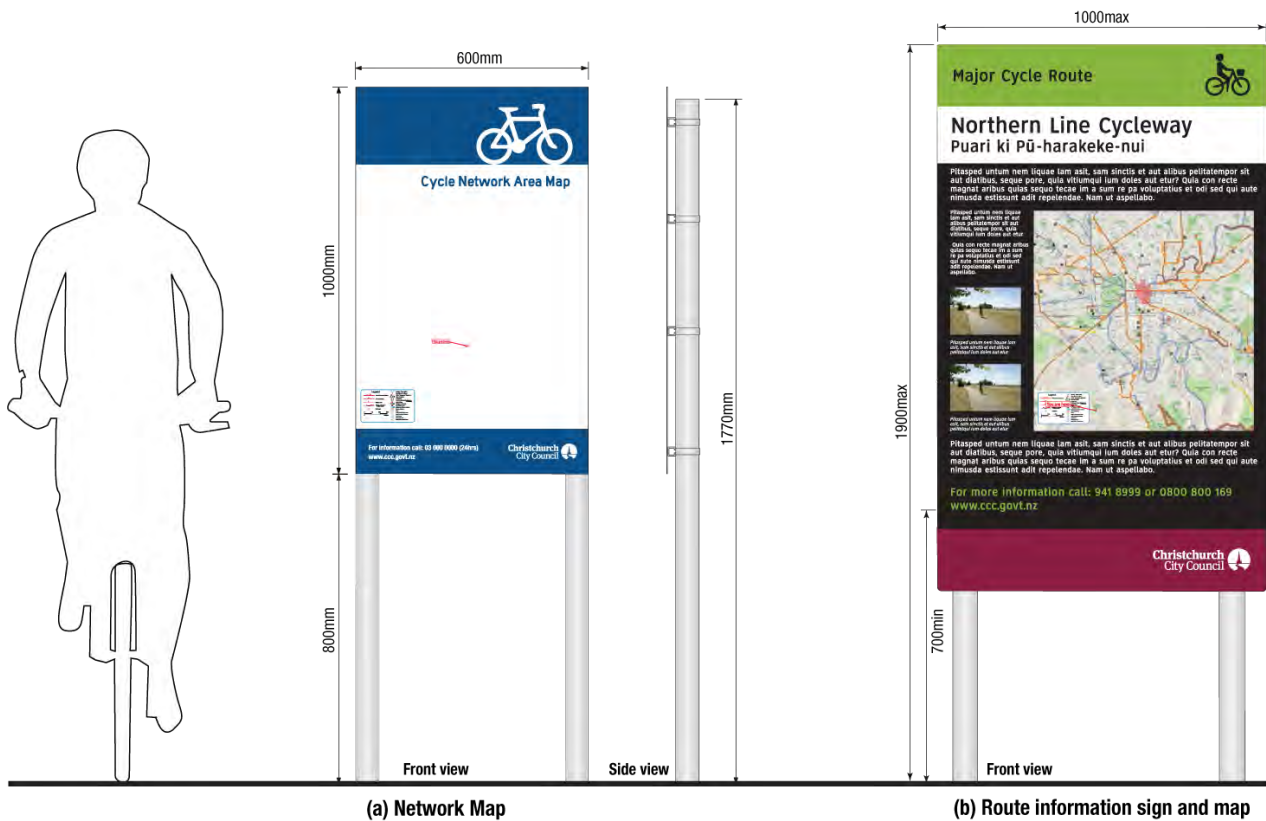

(c) Information Map Sign Viewing Bay recommended layout for on-road bicycle route

The diagram below shows recommended layout for a bicycle network map board viewing bay.

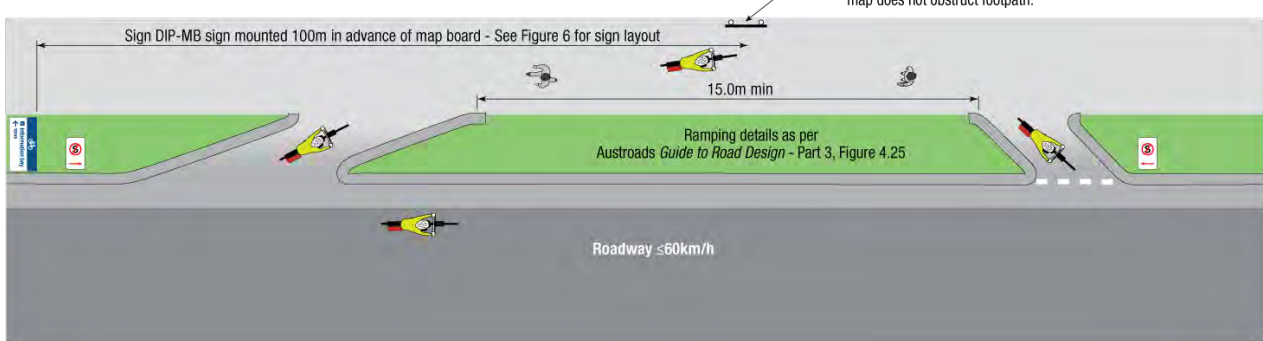

Notes

1. For on-road routes map signs are mounted off-road in a map viewing bay (layout as shown above) or in an adjacent parklands.
2. The map board is sited with sufficient surrounding space to permit comfortable viewing of the map without obstructing the normal flow of pedestrians or cyclists using the pavement area. The viewing area surrounding the map board is paved to minimise erosion.
3. Mount DIP-MB signs (see Figure 25e for layout) 100metres (or more to suit site conditions) in advance of map viewing bay in both directions with sign arrow indicating the road-side location. Install parking restriction signage to prevent overparking of the entrance and exit of the map viewing bay.

C.4 Local route signs

Local cycle route signs are a limited family of signs designed to help riders more easily find local destinations over shorter length routes, many in mixed-traffic residential street conditions. Local routes typically branch from, or feed to, primary routes. Local routes terminate at destinations such as suburban centres, educational and community facilities (schools, colleges, universities, pools, libraries, beaches) and public transport stations and interchanges.

The local route sign family uses fingerboards at each end of a route and markers in between to indicate route turnings. Local route facilities/services signs can also be used to indicate facilities adjacent to a local or other type of route.

Signs for local cycle routes are closely integrated with local street signs – cycling route markers are usually mounted below existing (or upgraded) street name signs. Where local fingerboards are used, these too are mounted on the same pole and immediately beneath existing street name signs – see example in Figure C.10.

C.4.1 Fingerboard signs – design details

Local route fingerboards (see Figure C.10) are designed to include the following design and sign content requirements:

- Local route fingerboards are double sided signs made from a 200mm aluminium extrusion street sign base.
- Local route fingerboards show only one main destination on the top line of the sign. A second, lower line can be used for facilities pictograms (FBL-1), important sub destinations (FBL-2SD) or other destinations on the end points of connecting primary routes (FBL-2PR).
- On local fingerboards the text on the upper line has a Cap X-height of 60mm. Lettering on the lower line has a Cap X-height of 45mm.
- Text and numbers are shown on fingerboards as per Section C2.1 of this appendix.
- A direction arrow 100mm wide (see Figure C.2) is located on the fingerboard at the opposite end to the sign mounting and pointing towards the direction of travel.
- Destination names are aligned to the distance numerals and direction arrow.
- Distances to destinations are located on the same line as the associated destination and between the destination and the direction arrow.
- A blue bicycle symbol is located at the mounting end of each sign face. The bicycle faces the direction of travel.
- Fingerboard maximum length is 1200mm.
- Route branding is not used on local routes.

Figure C.10: Local route fingerboards – design layouts



C.4.2 Facilities/services fingerboards – design details

Facilities/services fingerboards (see Figure C.11) are designed to include the following design and sign content requirements:

- Facilities/services fingerboards show only one destination per sign. Pictograms used on the lower row of these signs are shown in Figure C.19.
- On these fingerboards the text has a Cap X-height of 60mm.
- Text and numbers are shown as per Section C2.1 of this appendix.
- A direction arrow 100mm wide (see Figure C.2) is located on the fingerboard at the opposite end to the sign mounting and pointing towards the direction of travel.
- Destination names are aligned to the distance numerals and direction arrow.
- Distances to destinations are located on the same line as the associated destination and between the destination and the direction arrow.
- A blue bicycle symbol is located at the mounting end of each sign face. The bicycle faces the direction of travel.
- Fingerboard maximum length is 1200mm.
- Route branding is not used on facilities/services signs.

Figure C.11: Local route facilities/services signs – design layouts

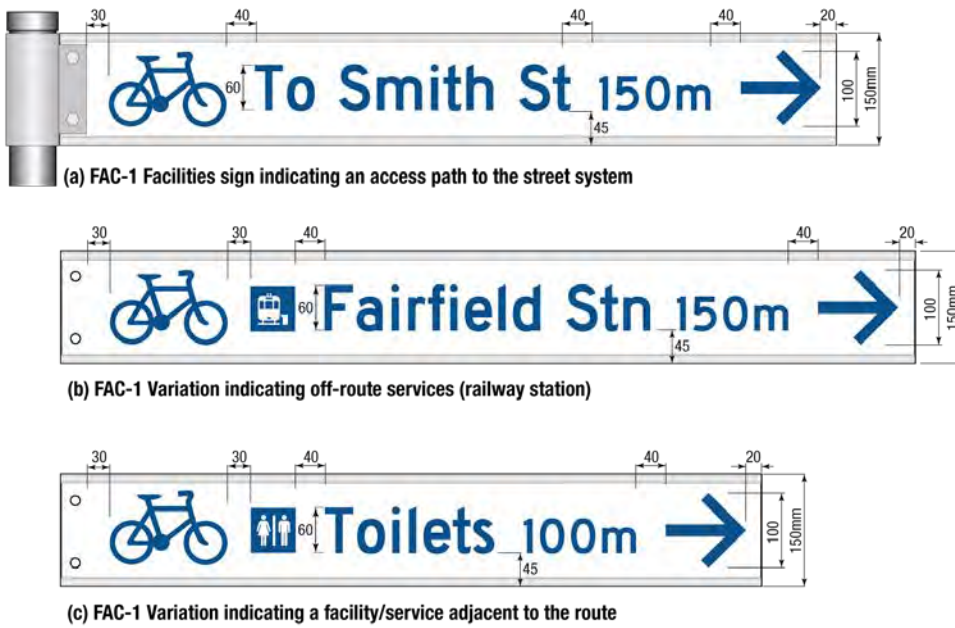

C.4.3 Route markers – design details

Local route markers (see Figure C.12) are designed to include the following design and sign content requirements:

- A white bicycle symbol (140x89mm) on a blue background is located at the mounting end of horizontal markers and in the top half of vertical markers. The bicycle symbol faces right for straight ahead markers and in the same direction as the arrow on all other marker variations.
- A blue direction arrow, located in the lower of the lower half of the marker, points towards the direction of travel.
- Route markers can be used on veloways and numbered primary routes. Route numbering (See Figure C.22) may be included in the sign layout of route markers. Branding may be separately affixed to poles above markers.
- Route numbering and branding is not used on local route markers.

Figure C.12: Local route markers - design layouts

Local cycle routes are signed between junction fingerboard signs using route markers

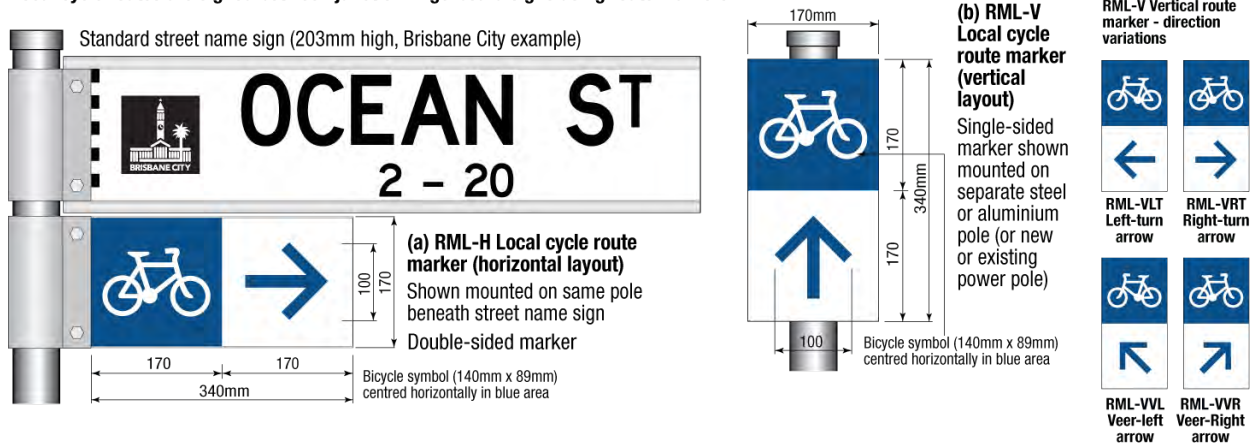

C.5 Tourism/recreational route signs

Long distance tourism and recreational routes are being developed as part of a growing community trend for active healthy recreation and travel. Cycle tourism and recreational routes can encompass a wide range of facilities from off-road trails along former railway corridors or mixed off- and on-road routes highlighting regionally significant tourism attractions. There are three types of signs for tourist/recreational routes: fingerboards for route indication; fingerboards to indicate facilities; and; route markers.

C.5.1 Route fingerboards – design details

Tourist/recreational route fingerboards (see Figure C.13) are designed to include the following design and sign content requirements:

- Fingerboards are double-sided signs constructed from 6mm aluminium sheet with lengths to suit longest combination of sign content elements. Fingerboard maximum length is 1200mm.
- A white bicycle symbol (157x100mm) on a brown background is located at the mounting end of each sign face. On fingerboards the bicycle symbol always faces in the direction of travel on both sides of the sign.
- The maximum height of fingerboards is two lines of text – a sub destination and a focal point.
- A 100mm wide direction arrow as per Figure C.2, located on the fingerboard at the opposite end to the sign mounting, points towards the direction of travel.
- Destination names are aligned to the distance numerals and direction arrow.
- Distances to destinations are shown (as per Section C2.1 of this appendix) and located between the destination name and the direction arrow.
- Route naming, numbering and branding may be included in the sign layout of fingerboards or separately affixed to poles above fingerboards (see Figure C.24 to Figure C.26).

Figure C.13: Tourist/recreational route fingerboards – design layouts

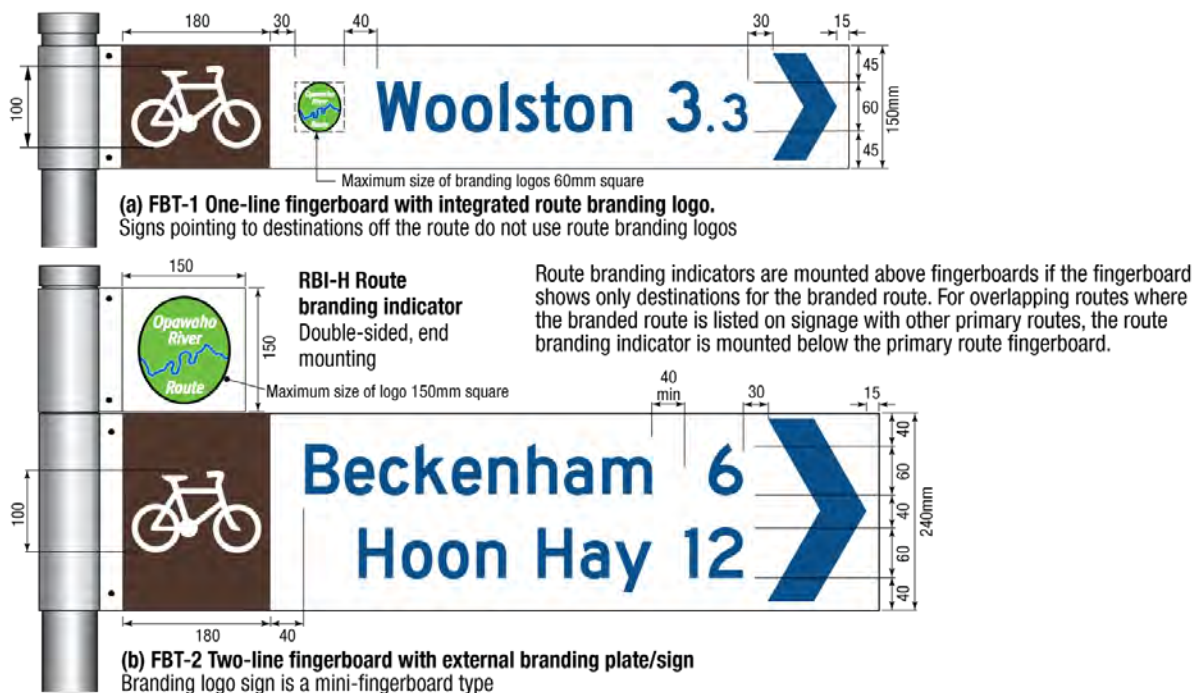

C.5.2 Facilities fingerboards – design details

Tourist/recreational facilities fingerboards (see Figure C.14) are designed to include the following design and sign content requirements:

- Fingerboards are double-sided constructed from standard 200mm aluminium street sign extrusion material with lengths to suit longest combination of sign content elements. Fingerboard maximum length is 1200mm.
- A white bicycle symbol (157x100mm) on a brown background is located at the mounting end of each sign face. The bicycle symbol always faces in the direction of travel on both sides of the sign.
- The maximum height of fingerboards is two lines of text – a main destination with subsidiary text below.
- Distances to destinations are shown (as per Section C2.1 of this appendix) and located between the destination name and the direction arrow. The text and numerals on the upper line have a Cap X-height of 60mm. Lettering and numerals on the lower line have a Cap X-height of 45mm.
- A 100mm wide direction arrow as per Figure C.2, located at the opposite end to the sign mounting, and pointing towards the direction of travel.
- Destination names are aligned to the distance numerals and direction arrow.

Figure C.14: Tourist/recreational facilities indication fingerboards – design layouts

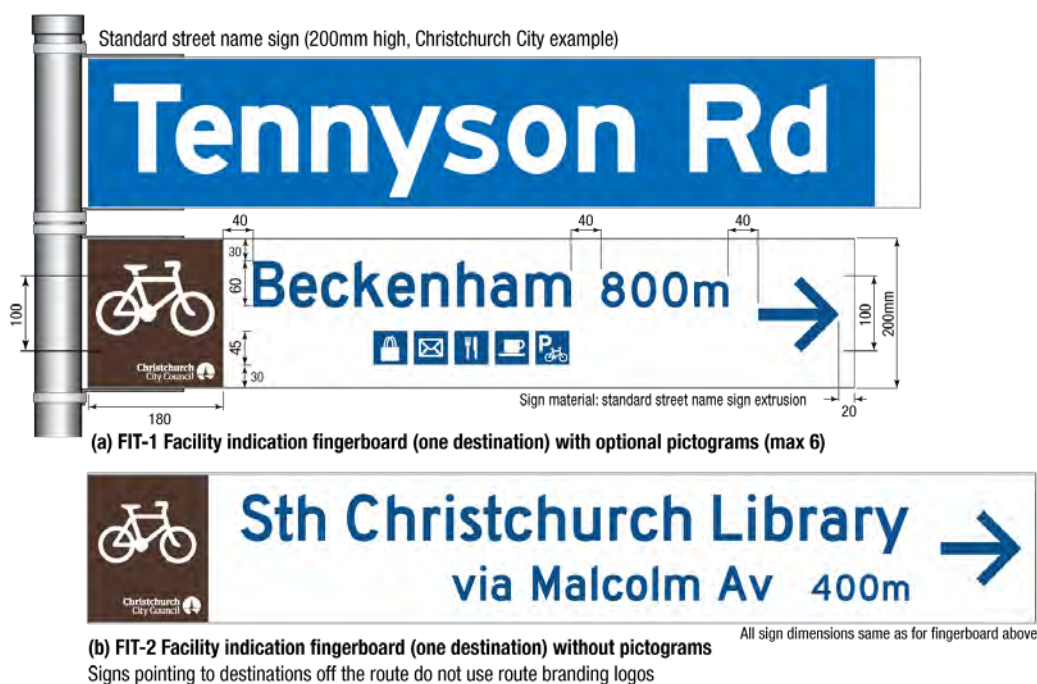

C.5.3 Tourist/recreational markers – design details

Tourist/recreational route markers (see Figure C.15) are designed to include the following design and sign content requirements:

- A white bicycle symbol (140x89mm) on a dark brown background is located at the mounting end of horizontal markers and in the top half of vertical markers. The bicycle symbol faces right for straight ahead markers and in the same direction as the arrow on all other marker variations.
- A blue direction arrow, located in the white half of the marker, points towards the direction of travel.
- Route numbering and branding (See Figure C.26g, i and j) may be included in the sign layout of route markers. Branding may be separately affixed to poles above markers.

Figure C.15: Tourist/recreational route markers – design layouts

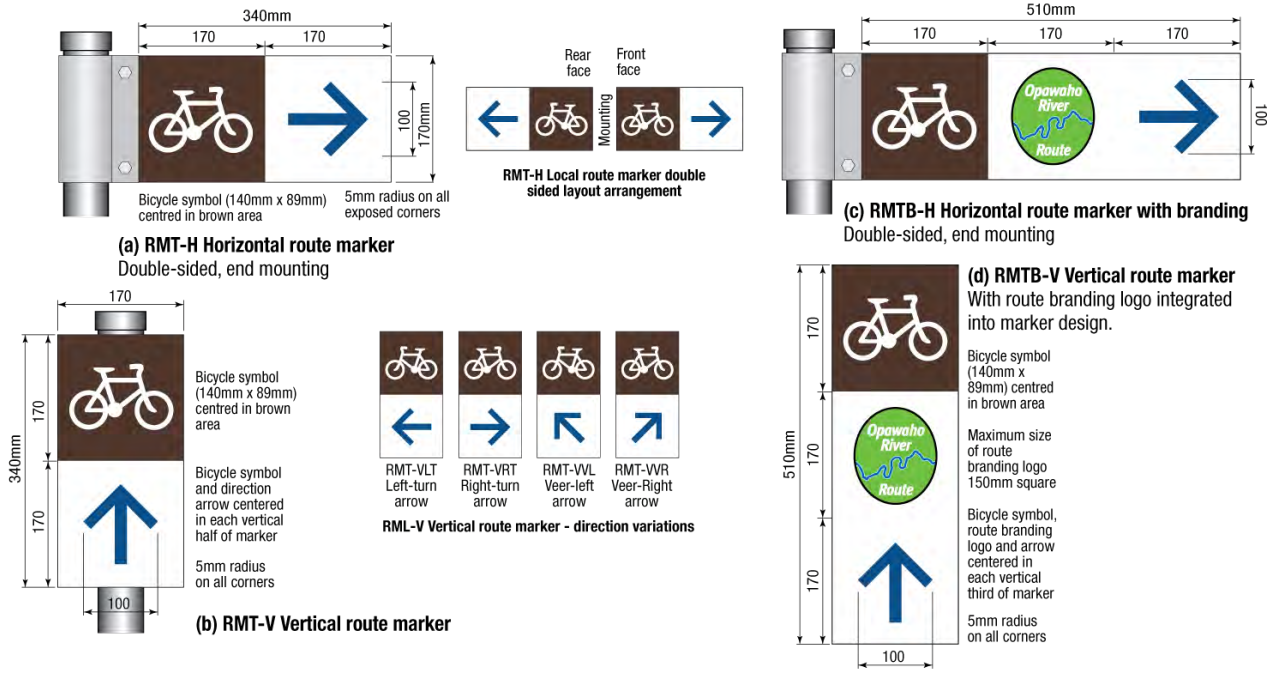

C.5.4 On-road training route markers – design details

On-road training route markers (see Figure C.16) are designed to include the following design and sign content requirements:

- A white bicycle symbol on a brown background is located in the top third of the sign. A blue direction arrow, located in the centre of the marker and points towards the direction of travel.
- A blue sports/fitness cyclist symbol (130x105mm) identical to VicRoads S-V113 Cyclist Symbol is centred in the lower third of the marker. This cyclist symbol points in the same direction as the arrow.
- Route numbering (see Figure C.16c) may be included in the layout of route markers.

Figure C.16: On-road training route markers – design layouts

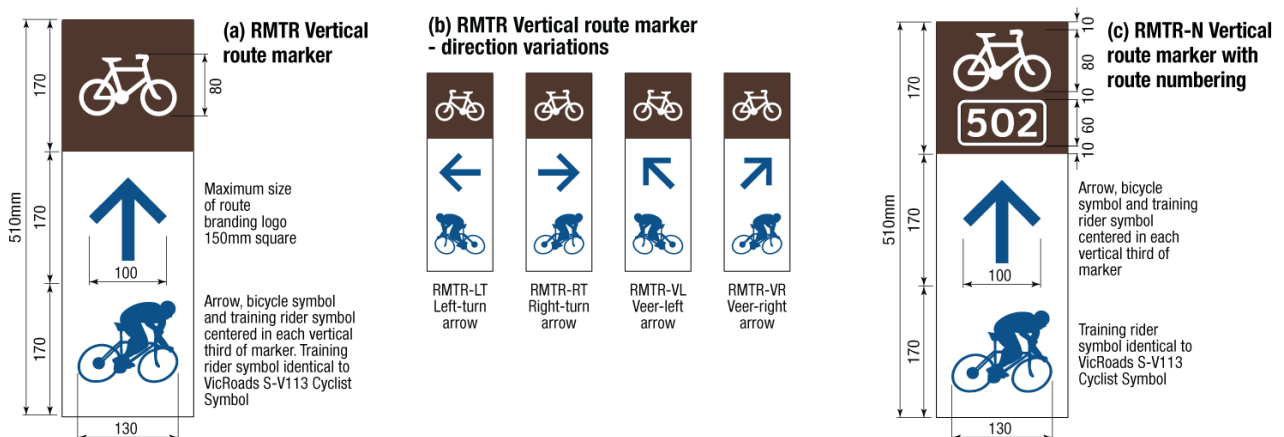

C.6 Detour route signs

Detours are specially identified routes (on- or off-road) providing alternative access while part of an established cycling route is closed due to construction. Detour signs are only installed when the route closure is in place for an extended period of time. For temporary closures, standard temporary warning/construction signs are used. Cycle route detour fingerboards and direction indication signs use black and white lettering and symbols on a AS2700 Y15 Sunflower yellow background with similar retro-reflectivity to primary cycling route signs.

C.6.1 Detour route fingerboards – design details

Route detour fingerboards (see Figure C.17a, b and c) are designed to include the following design and sign content requirements:

- The maximum height of fingerboards is two lines: a “Detour Route” box on the top line, and a destination on the lower line. The “Detour Route” box is black with white lettering.
- Text and numbers are shown on fingerboards as per Section C2.1 of this appendix. Destination names are aligned to the distance numerals and direction arrow.
- A direction arrow (as per Figure C.2), is located on the fingerboard at the opposite end to the sign mounting, pointing towards the direction of travel.
- A black bicycle symbol (157x100mm) is located at the mounting end of each sign face. The bicycle symbol always faces in the direction of travel.
- Fingerboard maximum length is 1200mm.
- Route numbering may be included as shown in Figure C.17c. Branding is not used on detour signs.

Figure C.17: Detour route fingerboard signs – design layouts

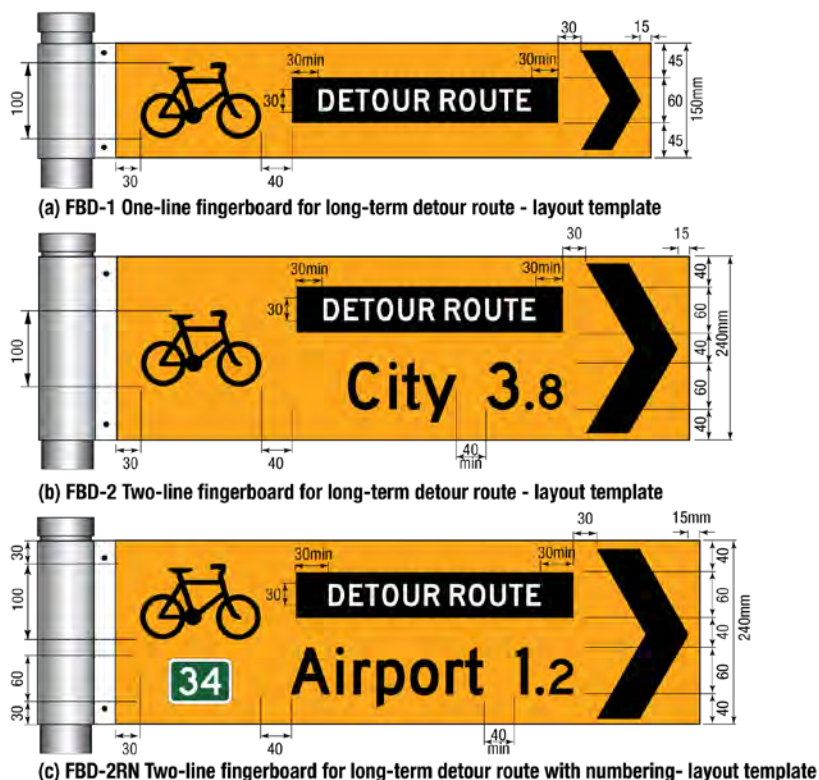

C.6.2 Detour route direction indication signs – design details

Route detour direction indication signs (see Figure C.18 a and b) are designed to include the following design and sign content requirements:

- A black 80mm wide direction arrow is located in the top half of the marker and points towards the direction of travel.
- A black bicycle symbol (157x100mm) is located in the top half of the sign to the right or opposite the direction indicated by the arrow (see detail diagrams in Figure C.18c). The bicycle symbol points in the same direction as the arrow or to the right for up arrows.

Figure C.18: Detour route direction indication signs - design layouts

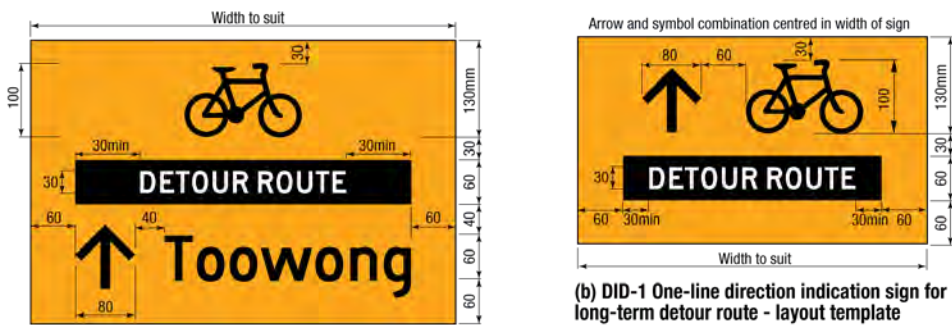

(a) DID-2 Two-line direction indication sign for long-term detour route - layout template

(b) DID-1 One-line direction indication sign for long-term detour route - layout template

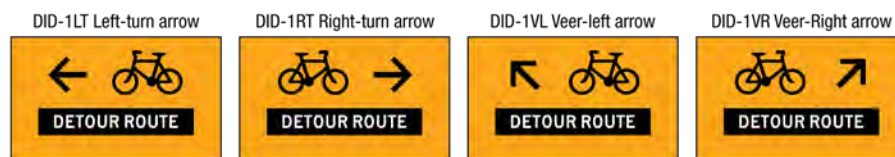

(c) Direction indication sign - direction variations

C.7 Pictograms for use on signs

Pictograms shown in Figure C.19 are recommended for use on local and tourist/recreation route fingerboards as required. Pictograms have been derived from AS1742 where available.

To ensure consistent reproduction pictograms are provided digitally to the sign fabricator and scaled proportionally when used on sign artwork.

Figure C.19: Pictograms for use on cycle directional signs



C.8 Directional pavement markings

Figure C.20 shows the layout, placement and recommended sizing for these markings. Half size standard bicycle pavement symbols are used in three combinations with standard size bicycle lane arrows to indicate the path of a cycling route.

The markings are positioned in advance of a route turning. The actual siting is determined by the road conditions and environment on the intersection approach. All sites need to be individually assessed taking likely user travel needs and conditions into consideration. Directional pavement markings are only intended to mark identified cycle routes. They are not intended for use on local access or connector paths.

Figure C.20: Directional pavement markings for cycle routes – design layouts

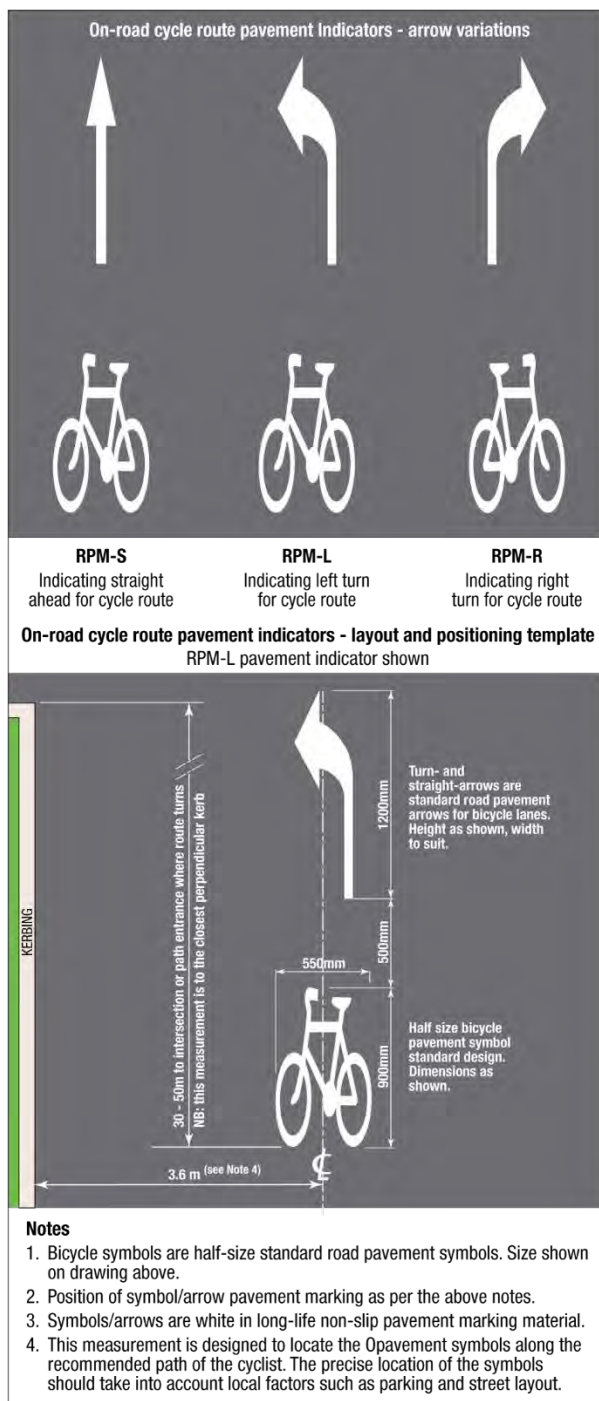

C.9 Numbered, named and branded routes

This section provides guidance on the sign design requirements for numbered, named or branded routes. These details are not applicable to local routes.

C.9.1 Signing numbered routes

There are three levels of numbered routes recommended (see Figure C.21):

- Alpha-numeric numbered routes (white letter/number on a blue background) based on an alpha-numeric code comprising the letter 'V' (for veloway) followed by the route number in the series.
- Two digit numbered routes (white numbers on a green background) are core primary routes in the metropolitan cycling network providing continuous cycle travel between major urban centres.
- Three digit numbered routes (white numbers on a dark brown background) are major urban or rural tourist/recreational facilities providing a continuous route throughout the region.

Figure C.21: Numbered routes on veloways, primary and tourist/recreational routes – number indicator design layouts

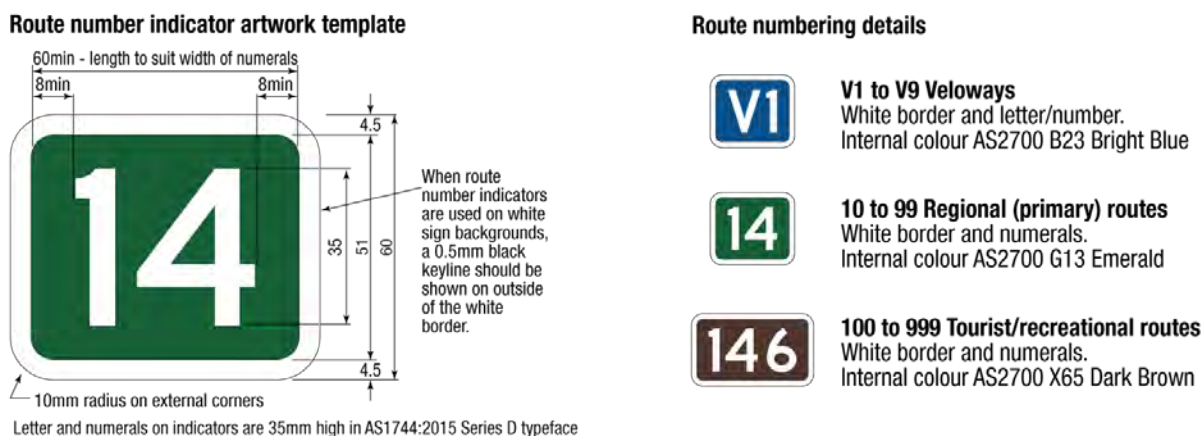

Primary route signs with route numbering indication (see Figure C.21, Figure C.22 and Figure C.23) are designed to include the following design and sign content requirements:

- Route number indicators are located next to destination names and at the opposite end of the line to the direction arrow or distance numerals.
- Route markers, when used on primary routes, can include route numbering as in Figure C.22d and e.
- Route numbers shown on signs can be associated with a single destination, a group of destinations or a route.
- When route numbering is associated with single destinations the route number indicator is shown on the same line as the destination.

If route numbering refers to all the destinations listed on the sign, the number indicator is shown below the bicycle symbol on fingerboards and markers, or to the left of the bicycle symbol in the blue sign header for direction indication, advance direction and reassurance direction signs (see examples in Figure C.22 and Figure C.23).

Where two or more destinations share the same route number, the number indicator is centred vertically on the destination names.

- Where routes overlap, number indicators are shown for all routes present. The route being followed is listed first (left side in a L-R group of numbers).

- Route numbering and route branding are separate systems with potentially overlapping segments. The examples in Figure C.22 a and b show fingerboards with three overlapping routes (26, 146 and a branded route).
- When a route branding logo is shown on the same destination line as a route number indicator, it is always displayed on the outside of the number indicator.

Figure C.22: Numbered route signs on primary and tourist/recreational routes –design layouts

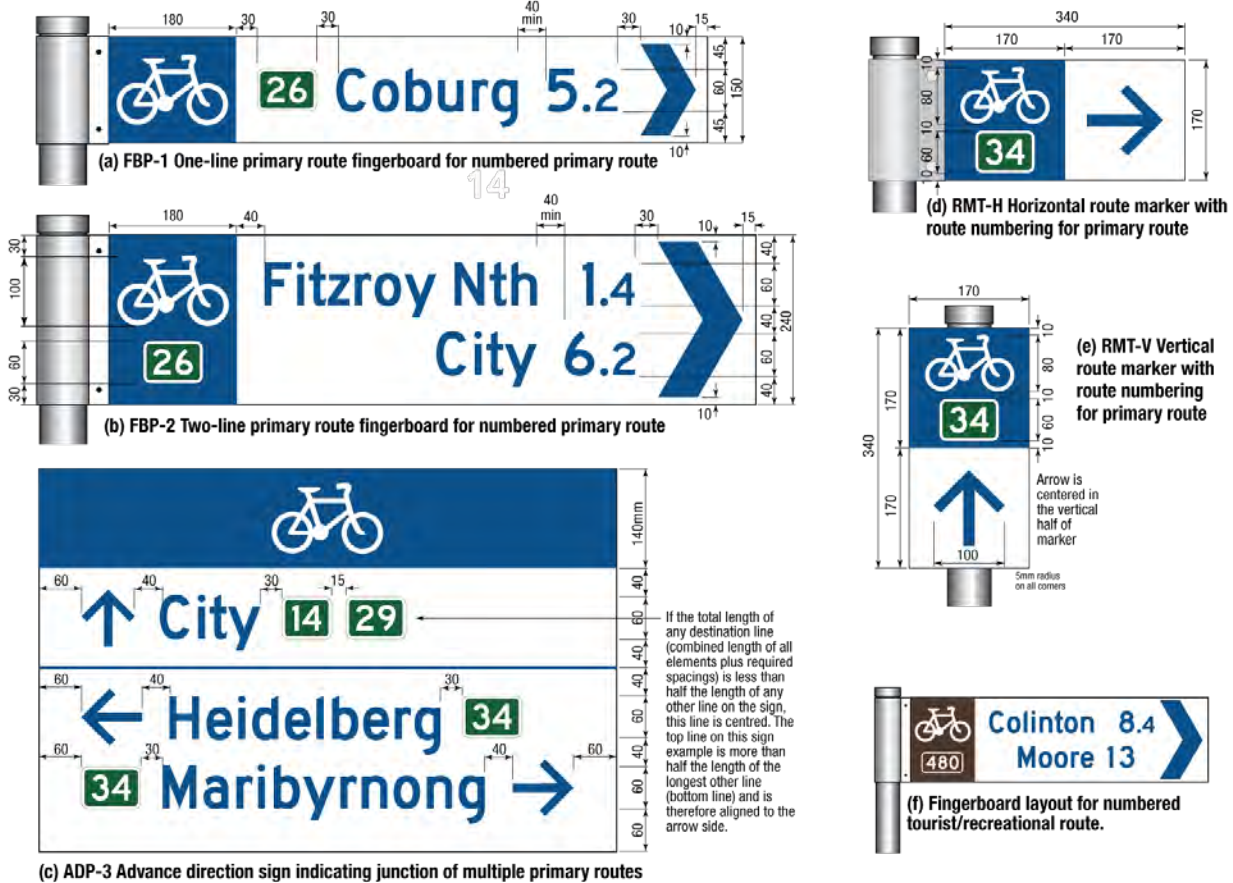
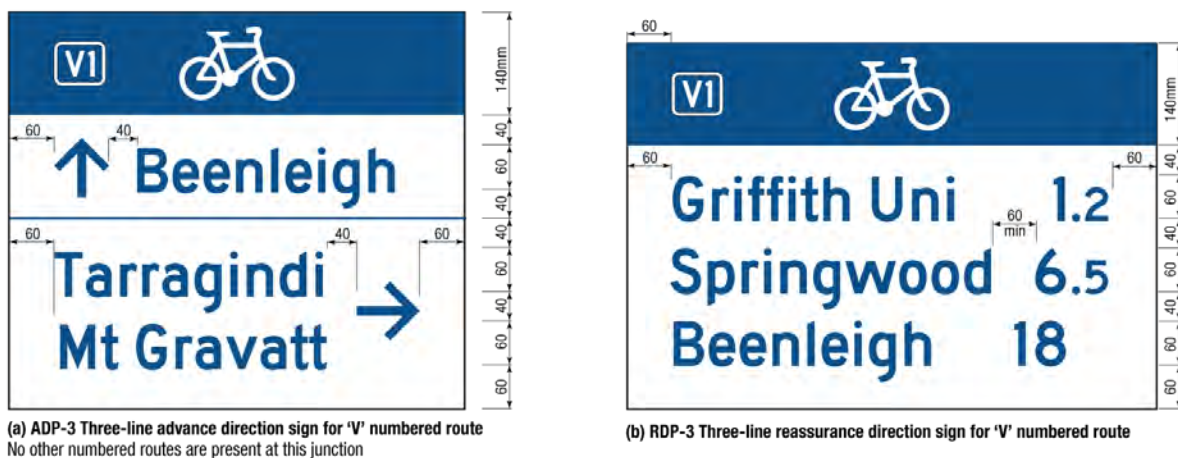

Figure C.23: Numbered route signs on veloways –design layouts



C.9.2 Signing named facilities

Veloway and primary route signs which include facility name indication (see Figure C.24 and Figure C.25) are designed to include the following design and sign content requirements:

- Facility name indication can be installed as a separate external sign mounted above the route sign (see Figure C.24) or integrated into the sign design (see Figure C.25).
- Facility names are shown in white lettering (mixed upper and lower case) on a blue background. When used on separate external signs the lettering Cap-X height is 50mm. On integrated sign designs the lettering Cap-X height is 30mm within a 60mm blue box.
- Lengthy facility names are abbreviated. Where the length of a facility name exceeds the length of destination line information (arrow, text, distance etc.) either abbreviate the facility name or use the more condensed typeface AS1744:2015 Series C.

Figure C.24: Named facility signs for veloways and primary routes (external name plate) – design layouts

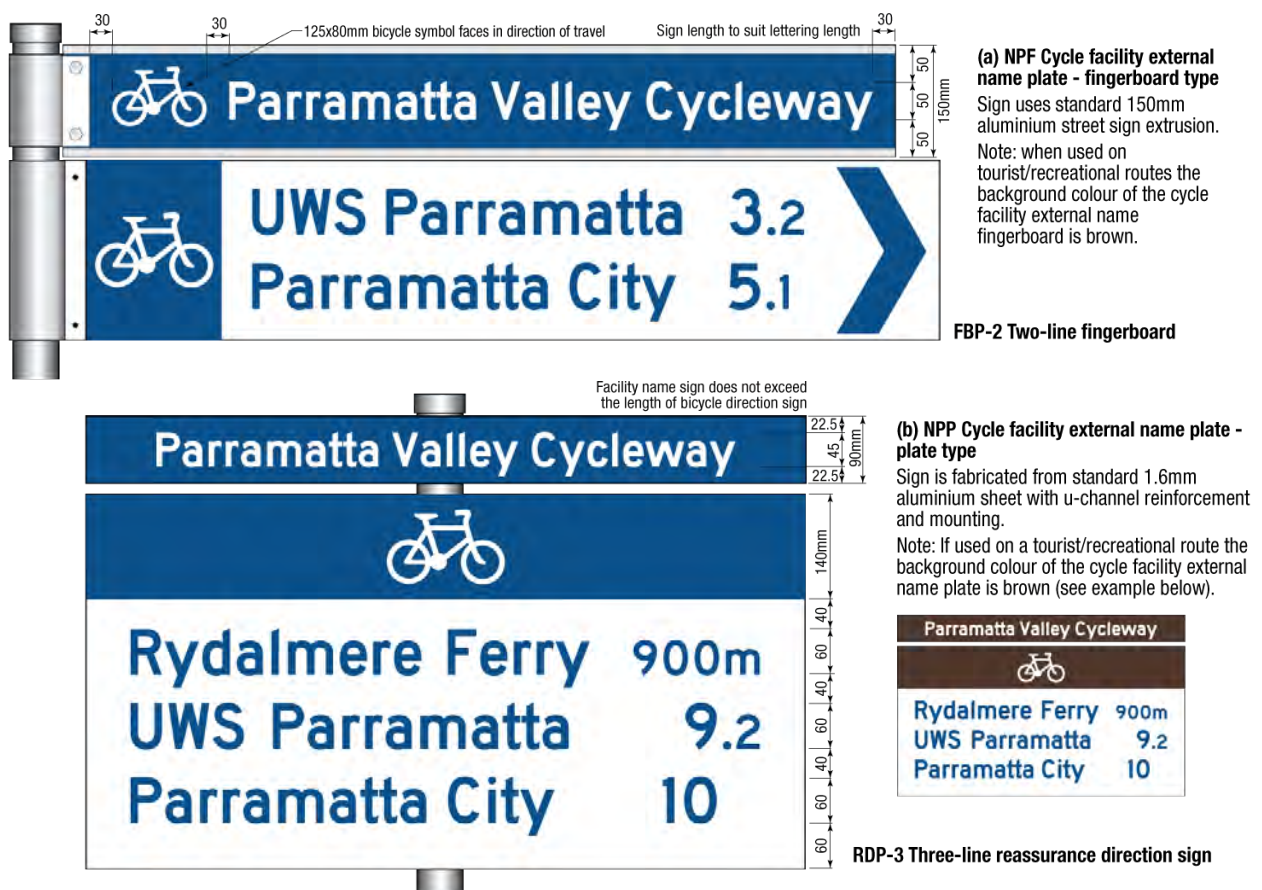
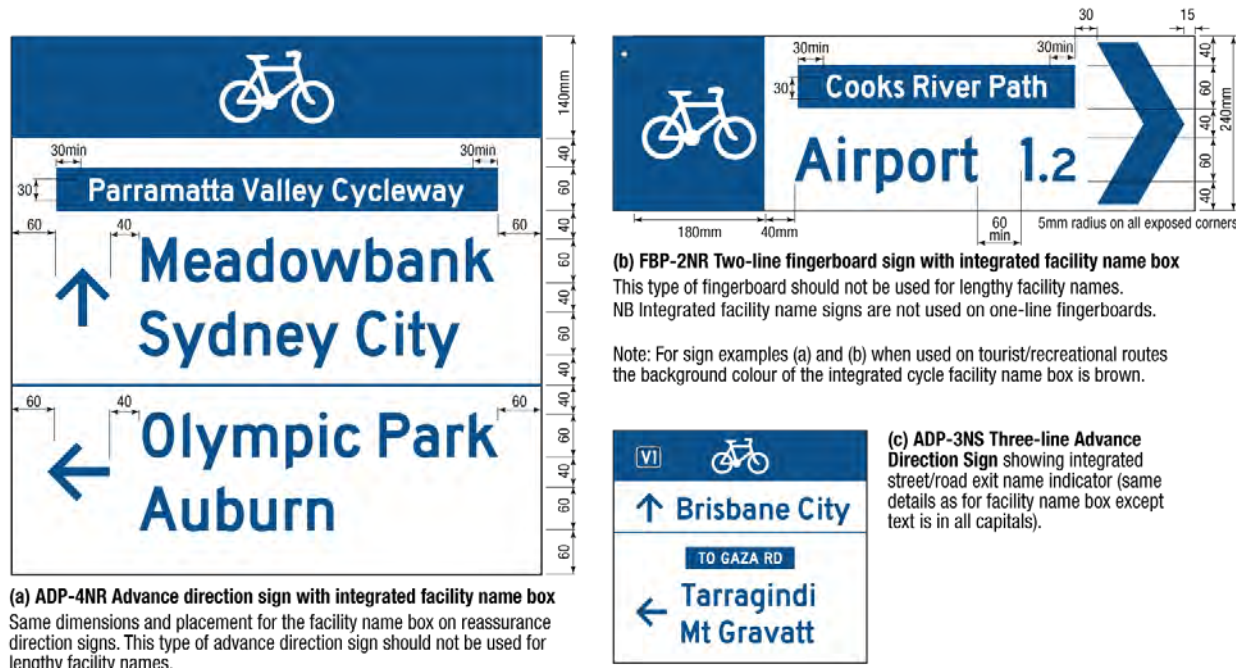

Figure C.25: Named facility signs for veloways and primary routes (name integrated) – design layouts



C.9.3 Signing branded routes

Primary and tourist/information route signs which include route branding indication (see Figure C.26) are designed to include the following design and sign content requirements:

- Logos are the preferred method of branding. Logos use a simplified design and are instantly recognisable. Use of colour in logos is minimised (one or two colours only). The logo colour(s) is to provide maximum contrast with the sign background.
- Cycle route branding can be integrated into sign designs or installed as a separate sign above or below fingerboards (see examples in Figure C.26a and b).
- Route branding logos are always located on the white background area of the sign and on the same line as the associated destination name opposite any direction arrow.
- Route numbering always takes precedence over route branding.
- When route branding logos are used on signs, the logos are placed adjacent to the direction name (or route number if present) and at the opposite end of the line to the direction arrow or distance numerals. On fingerboards, route branding logos are placed on the mounting pole side of the related destinations.
- Branding logos match the height of the destination lettering. Where different destinations use different branded routes, locate the logos for each branded route on the same line as the related destination.
- Route branding and route numbering are separate systems with potentially overlapping segments. Figure C.26h shows a reassurance direction sign for Route 12 which lists a route destination (Newtown) at a junction with Route 19. Because the branded route – the Inner City Ring Route – overlaps Route 19, the route branding and route numbering are shown on the same destination line. Always show route numbers closest to the destination name.
- On advance direction signs, where two or more destinations share the same route branding, centre the branding logo vertically on the destination names.
- On reassurance direction signs where all listed destinations are part of a branded route, show the route branding logo on the left side in the blue sign header area, and to the right of any route number indicator in the case of overlapping routes.

Figure C.26: Branded route signs on veloways, primary and tourist / recreational routes – design layouts

Route branding logos used in examples on this page. These examples are used for demonstration purposes only and are not intended to depict actual routes

 Example: Inner City Ring Route (urban)
A branded ring route approx 2km from city centre. Route uses segments of other radial and cross city routes.

 Example: Capital City Route (urban/tourist/recreational)
A branded circuit route approx 5km from city centre. Route number 146. Route uses segments of other radial and cross city routes.

 Example: Major Cycle Route Network (urban)
All 13 high-quality routes (the core of the Christchurch primary cycle route network) are branded with MCR logo.

 Example: Brisbane Valley Rail Trail (rural/tourist/recreational)
Rural rail trail using a mixture of off-road trails and on-road mixed-traffic connections. Route number 480.

When integrated into the sign face, branding logos are 60x60mm maximum. When used on an external plate (as shown below right) they can be 150x150mm maximum.

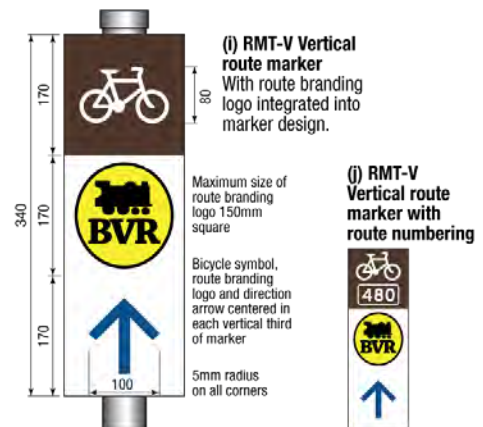
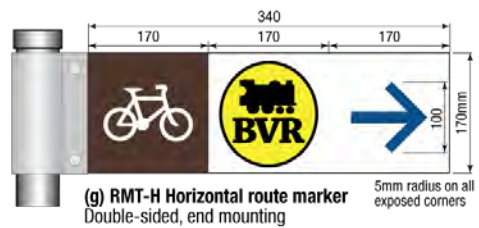
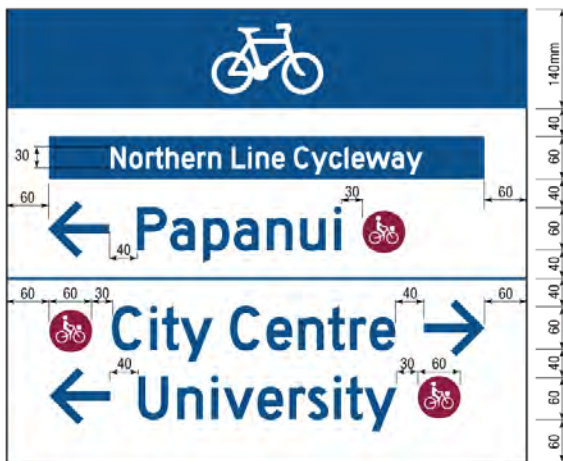
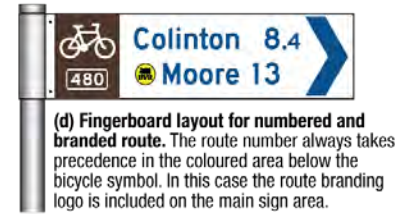
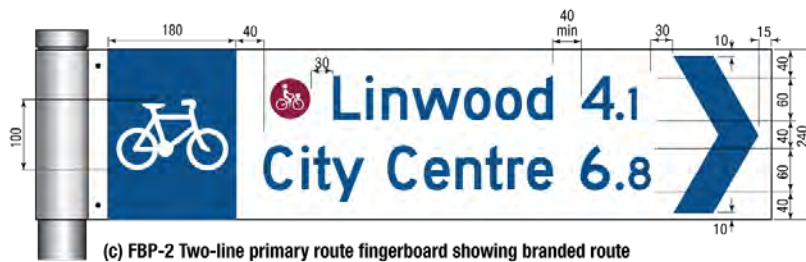
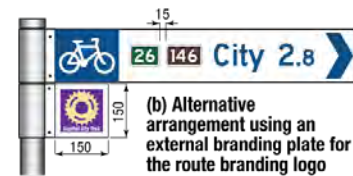
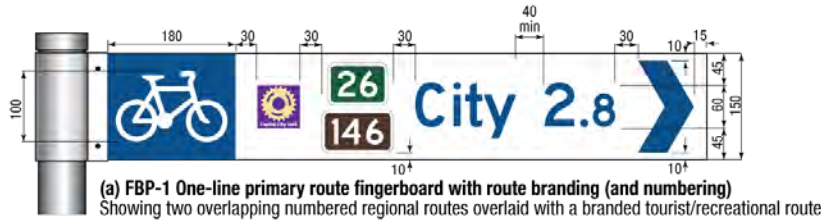

This example shows a RDP-3 sign for numbered route (12) indicating upcoming destinations with numbered cross routes (88 & 19). Route 19 is also branded as the Inner City Ring Route at this junction.



Austroads

Level 9, 287 Elizabeth Street
Sydney NSW 2000 Australia

Phone: +61 2 8265 3300

austroads@austroads.com.au
www.austroads.com.au